

THE
HAILES FAMILY
TREE

COMPILED MOSTLY FROM
ORIGINAL WORKS BY: VERA MARY WARD
HELEN NANKERVIS
NGAERE HAILES

Apologies in advance for omissions and mistakes. If you are able to assist in correcting mistakes, adding missing information or hints on a better lay out please contact: Russell Hailes, 22 Haast Close, LOWER HUTT

Issue 2 26 October 1993

If you are able to supply information, what I would like is :

1. Full Name
2. Known(nick) Name
3. Birth Date and Location
4. Present Location (where you live)
or Date & Location of Death
5. Same for the marriage partner and Children
6. Where and when Married

And anything else you may want to say about the person/s, family stories or Family History (copies of photos or anything else of interest) which may be included in a "Family History Book" at some further stage.

SECTION 1

THE EARLY YEARS

1st Generation

2nd Generation

3rd Generation

James HAILES
b
d
Ann FRANCES
b
d

Ann HAILES
b 8 April 1775 New House Mamble Wn.
d

James HAILES
b 8 Oct 1778
d
Sarah
b 1801
d

Walter HAILES
b 18 Jan 1781
d
Lucy BALDWIN
b 17 April 1781
d

Frances HAILES
b 10 Nov 1805
d

James HAILES
b 23/26 March 1807
d

Ann HAILES
b 8 Oct 1809
d

Edward HAILES
b 14 Aug 1812
d

Edward HAILES
b 15 Nov 1782
d 5 Aug 1859 139 Horsley Field Wolverhampton Stafford
Mary Frances PARKER 14-8-1809 @ Neen Sollars
b 25 Mar 1790 Chaddeley Corbett RC
d 13 Dec 1860 Horsley Field Wolverhampton Stafford

Mary Ann HAILES md John GILES
b 7 Nov 1809
d 6 Mar 1874

Section 2

Frances Mary HAILES md WILLIAMS
b 18 Jan 1811
d 27 March

Helen HAILES md John TREVIS 21-2-1832 @ Wardow
b 20 March 1812
d

Section 3

Edward HAILES md Elizabeth ALBOT
b 28 Dec 1813
d

Section 4

Teresa HAILES md Joseph PENDRELL
b 27 March 1816
d

no children

Walter Mary HAILES md Frances Ann WARD
b 14 March 1818 Mamble Worcestershire, England
d 19 May 1881 @ Kohai, Kaikoura

Section 5

George James HAILES md Lucy J PENDRELL
b 12 April 1820
d 1892

Section 6

Winifred HAILES
b 17 Dec 1821
d 30 Nov 1858

Agnes HAILES Spinster
b 6 Dec 1823
d 27 Dec 1881

Elizabeth HAILES md George John ALBOT
b 2 Feb 1826
d 2 April 1863

Section 7

Barbara Winifred HAILES
b 25 May 1828 Worcester, St George
d 7 May 1888

James HAILES
b 6 Jan 1831
d 11 Dec 1840

Richard HAILES
b 12 June 1833
d 20 Nov 1866

Joseph HAILES
b 4-3-1785
d
Mary WINIFRED
b
d

Joseph HAILES
b
d

Richard HAILES
b 5-4-1787
d
Catherine
b
d

David HAILES

Index

Section 8

5-11

SECTION 2

MARY ANN HAILES
&
JOHN GILES

3rd Generation

[1-1] Mary Ann HAILES
b 1809
d
John GILES
b
d

4th Generation

Helen GILES
b 1841
d 1916
Louis DRAGER
b
d
Helen came to New Zealand with her Uncles
Walter Mary HAILES & George James HAILES
on board the Edward Thornhall which arrived
at Nelson in 1862

5th Generation

Wilhemina Mary DRAGER md John MURRAY
b 1863
d 1969 P2-2

Hubert Louis DRAGER
b 1867
d 1867

Lucy Ann DRAGER md William GALBRAITH
b 1868
d 1946 P2-5

Christopher Louis DRAGER md Edith HARVEY
b 1870
d 1957 P2-11

Otto Giles DRAGER md Mary NEWMAN
b 1873
d 1936 P2-13

Leonard S DRAGER md Margaret SHALDRICK
b 1875
d 1956 P2-13

Fritz A DRAGER md Edith COLLINS
b 1878
d 1955 P2-14

Winifred Rose DRAGER md Thomas LLOYD
b 1880
d 1915 P2-15

Bertha Ellen DRAGER
b 1883
d 1942

5th Generation

6th Generation

7th Generation

[2-1]Wilhemina Mary DRAGER
b 1865
d 1969
John MURRAY
b 1864
d 1940

Alice MURRAY
b
pl
Charles DOGGETT
b
pl

Doreen DOGGETT md Hugh O'FLAHERTY
b
pl
Ngairé DOGGETT md Arthur ROE
b
pl
Mary (Moi) DOGGETT md Charles BEAMISH
b
d
John DOGGETT md Gweneth ROBINSON
b
pl
Julien DOGGETT md Bernard BIRD
b
pl

P2-2
P2-3
P2-3
P2-3
P2-3

Teresa MURRAY
b
pl
(1)Edward HAYES no children
b
pl
(2)Theo BARTNICZAK
b
pl

Rosetta MURRAY
b 1903
pl

Eileen MURRAY
b
pl

Albert MURRAY
b twin
pl
Kathleen SALMON
b

Maurice MURRAY md Mary BYRNE
b
pl
Ann MURRAY md George SHAW
b
pl
Gerard MURRAY md Raewyn HAYWARD
b
pl
Mary MURRAY md Ross ALLAN
b
pl
Paul William MURRAY
b
b
d

P2-4
P2-4
P2-4
P2-4

Agnes MURRAY
b twin
d
Rita MURRAY spinster
b 1910
pl

7th Generation

8th Generation

9th Generation

[2-2]Doreen DOGGETT
b
pl
Hugh O'FLAHERTY
b
pl

Kathleen O'FLAHERTY
b
pl
Denis M'DONALD
b
pl

Brigid M'DONALD
b
pl
Kevin M'DONALD
b
pl
Brenda OAKLEY
b
pl
Louise OAKLEY
b
pl
Robert MATHESON
b
pl
Graham MATHESON
b
pl
Kyle MATHESON
b
pl
Jennifer MATHESON
b
pl
Erin MATHESON
b
pl

Ann O'FLAHERTY
b
pl
Raymond OAKLEY
b
pl

Helen O'FLAHERTY
b
pl
Kenneth MATHESON
b
pl

Brian O'FLAHERTY
b
pl

Martin O'FLAHERTY
b
pl

Patricia O'FLAHERTY
b
pl

7th Generation

8th Generation

9th Generation

[2-2]Ngairu DOGGETT
b
pl
Arthur ROE
b
pl

Allan ROE
b
pl
Raewyn EBBETT
b
pl

Victoria ROE
b
pl
Charlotte ROE
b
pl
Anna ROE
b
pl

John ROE
b
pl
Wendy WOODS
b
pl

Michael ROE
b
pl
Karen ROE
b
pl

Maureen ROE
b
pl
David CHATTERTON
b
pl

[2-2]Mary (Mol) DOGGETT
b
pl
Charles BEAMISH
b
pl

Jennifer BEAMISH
b
pl
Terry BENNETT
b
pl

Karen BENNETT
b
pl
Grant BENNETT
b
pl
David BENNETT
b
pl

Kevin BEAMISH
b
pl

[2-2]John DOGGETT
b
pl
Gweneth ROBINSON
b
pl

Robyn DOGGETT
b
pl
Lynden HUNT
b
pl

Kerry HUNT
b
pl
Carla HUNT
b
pl

David DOGGETT
b
pl
Katherine MAILLEY
b
pl

Charmaine DOGGETT
b
pl
Luke DOGGETT
b
pl
Karine DOGGETT
b
pl

Shirley DOGGETT
b
pl
Dean WATERHOUSE
b
pl

James WATERHOUSE
b
pl
Craig WATERHOUSE
b
pl
Scott WATERHOUSE
b
pl
Brett WATERHOUSE
b
pl

[2-2]Julien DOGGETT
b
pl
Bernard BIRD
b
pl

Ian BIRD
b
pl
Celeste SABLE
b
pl

Mark BIRD
b
pl

Patricia BIRD
b
pl
Thomas HEARD
b
pl

Neil BIRD
b
pl

7th Generation

8th Generation

9th Generation

[2-2]Maurice MURRAY
b
pl
Mary BYRNE
b
pl

Bernadette MURRAY
b
pl
Graham BROCKLEBANK
b
pl
Joseph MURRAY
b
pl
Nicla REEVE
b
pl
Kathleen MURRAY
b
pl
Patrick MURRAY
b
pl
Frances MURRAY
b
pl
David MURRAY
b
pl
Michael MURRAY
b
pl
Anthony MURRAY
b
pl

Cara Jane BROCKLEBANK
b
pl

[2-2]Anne MURRAY
b
pl
George SHAW
b
pl

Michael SHAW
b
pl
Alison MARTIN
b
pl
Karen SHAW
b
pl
UNKNOWN
b
pl
Andrew SHAW
b
pl
Ian SHAW
b
pl
Stephen SHAW
b
pl
Bridget SHAW
b
pl

Suzannah SHAW
b
pl
Josiah SHAW
b
pl
Lana SHAW
b
pl
Hannah
b
pl
Jessica
b
pl

[2-2]Gerard MURRAY
b
pl
Raewyn HAYWARD
b
pl

Peter MURRAY
b
pl
Teresa MURRAY
b
pl
Christopher MURRAY
b
pl
Robin MURRAY
b
pl
Nigel MURRAY
b
pl
Stephanie MURRAY
b
pl
Angela MURRAY
b
pl
Brian MURRAY
b
pl

[2-2]Mary MURRAY
b
pl
Ross ALLAN
b
pl

Charlotte ALLAN
b
pl

5th Generation

6th Generation

7th Generation

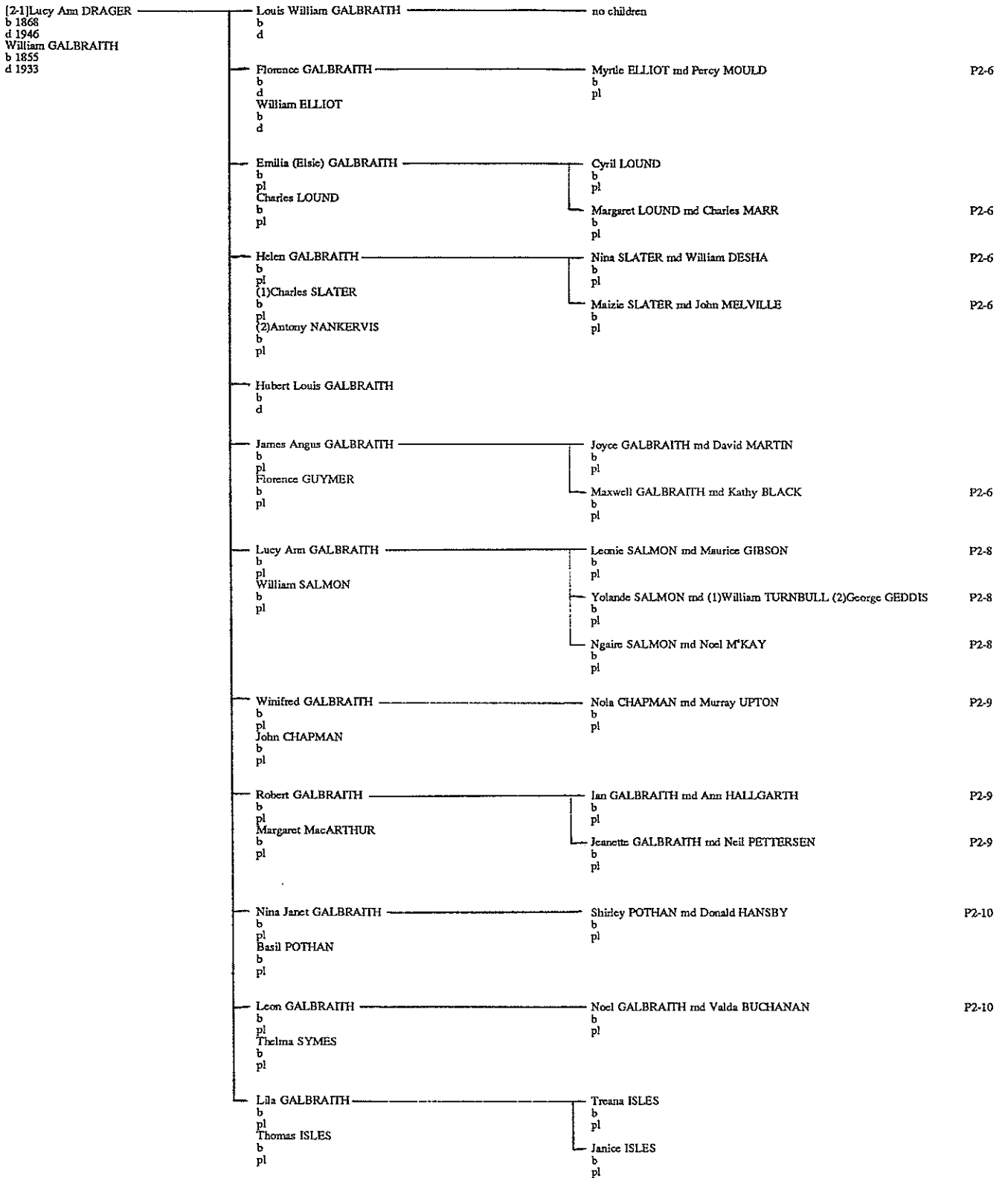

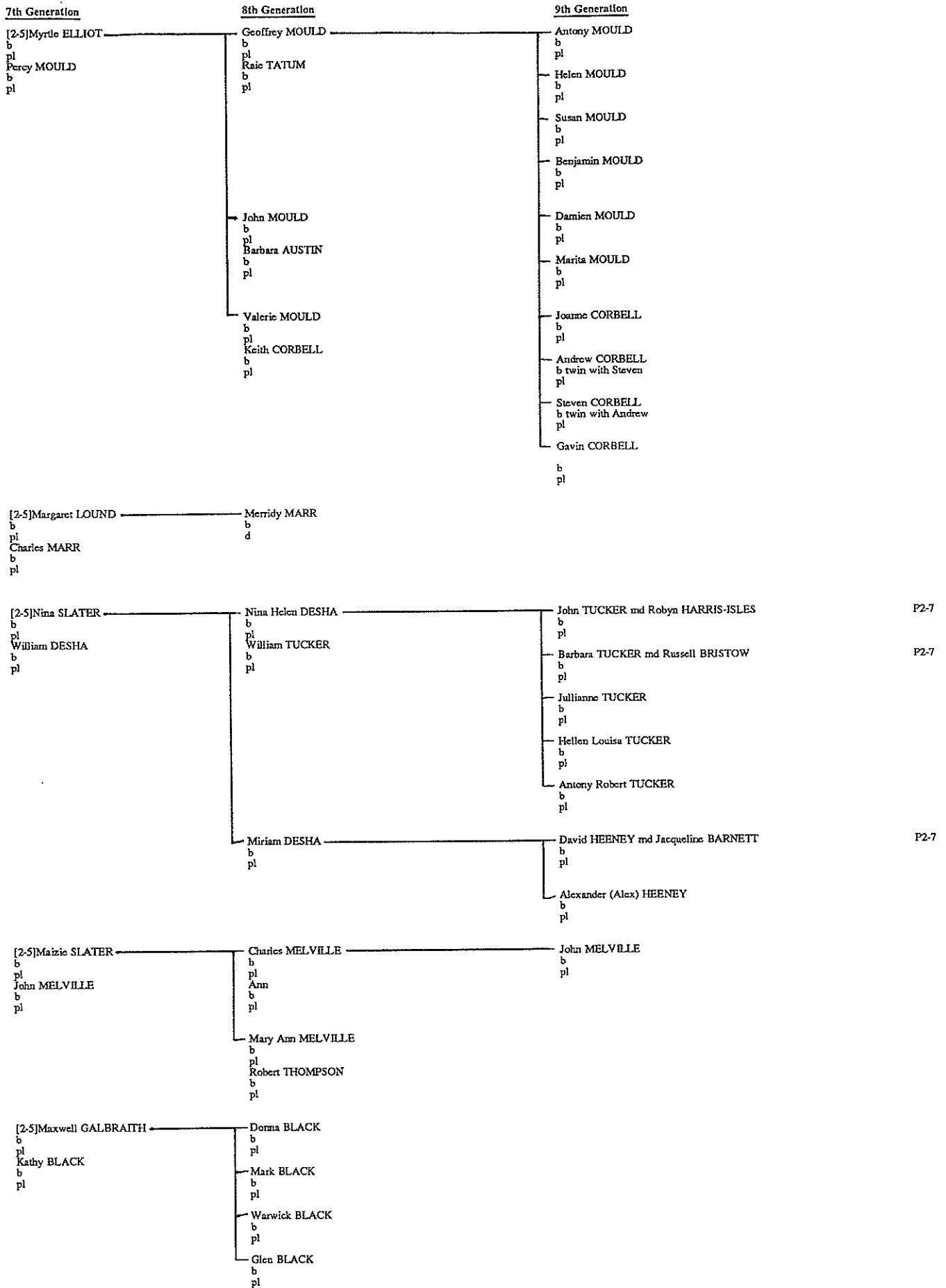

9th Generation

10th Generation

[2-6]John TUCKER ————— Ben TUCKER
b b
pl pl
Robyn HARRIS-ISLES
b
pl

[2-6]Barbara TUCKER ————— Emma BRISTOW
b b
pl pl
Russell BRISTOW
b
pl ————— Kate BRISTOW
b
pl

[2-6]David HEENEY ————— Kimberley HEENEY
b b
pl pl
Jacqueline BARNETT
b
pl ————— Tiffany HEENEY
b
pl

7th Generation

8th Generation

9th Generation

[2-5] Leonie SALMON
b
pl
Maurice GIBSON
b
pl

Desmond GIBSON
b
pl
Jenny GREEN
b
pl

Alison GIBSON
b
pl
Paul GITMANS
b
pl

Lisa GITMANS
b
pl
Michael GITMANS
b
pl
Jason GITMANS
b
pl

Yolande GIBSON
b
pl
(1) Graham DENT
b
pl
(2) Robert MUNRO
b
pl

Paul DENT
b
pl
Hayden DENT
b
pl

Michael GIBSON
b
pl
Lillian
b
pl

Bradley GIBSON
b
pl

Peter GIBSON
b
pl
Marilyn FRANKLIN
b
pl

Natalie GIBSON
b
pl
Ryan GIBSON
b
pl

Michelle GIBSON
b
pl

[2-5] Yolande SALMON
b
pl
(1) William TURNBULL
b
pl
(2) George GEDDIS
b
pl

Lynne TURNBULL
b
pl
Ian GOODWIN
b
pl
Fiona Lisa TURNBULL
b
d

Adele GOODWIN
b
pl

[2-5] Ngaire SALMON
b
pl
Noel M'KAY
b
pl

Shona M'KAY
b
d

Ian M'KAY
b
pl
Dawn STEVENS
b
pl

Kara STEVENS
b
pl
Sharman STEVENS
b
pl

Kevin M'KAY
b
pl

Marie M'KAY
b
pl
UNKNOWN
b
pl

Kylie
b
pl
Jarrod
b
pl
Rachael
b
pl

Brian M'KAY
b
pl

Kerry M'KAY
b
pl
Willis
b
pl

Sheryl M'KAY
b
pl
UNKNOWN
b
pl

Jade
b
pl
Jamic
b
pl
Cannon
b
pl

Tania M'KAY
b
pl

George M'KAY
b
pl

7th Generation

8th Generation

9th Generation

[2-5]Nola CHAPMAN
b
pl
Murray UPTON
b
pl

Diane UPTON
b
pl
Graeme ROBINSON
b
pl

Shirley ROBINSON md Dean M'BRIDE
b
pl

Carroll UPTON
b
pl
James M'ANENEY
b
pl

Craig M'ANENEY
b
pl
Lisa M'ANENEY
b
pl
Deanne M'ANENEY
b
pl

Eric UPTON
b twin with John
pl
Diane SMITH
b
pl

Ursula UPTON
b
pl
Hilary UPTON
b
pl
Fluer UPTON
b twin with Matthew
pl
Matthew UPTON
b twin with Fluer

John UPTON
b twin with Eric
pl
Barbara WRACK
b
pl

Phillipa UPTON
b
pl
Elizabeth UPTON
b
pl

Keith UPTON
b twin with Kevin
pl
Carla RAVI-PINTO
b
pl

Warrick UPTON
b
pl

Kevin UPTON
b twin with Keith
pl
Gail DONALDSON
b
pl

Michael UPTON
b
pl
Tracey UPTON
b
pl

Phillip UPTON
b
pl
Christine CARR
b
pl

Bradley UPTON
b
pl
Allison UPTON
b
pl

Noel UPTON
b
pl
Lynne PEARSE
b
pl

Dorma UPTON
b
pl
Guy UPTON
b
pl

[2-5]Jan GALBRAITH
b
pl
Ann HALLGARTH
b
pl

Sean GALBRAITH
b
pl
Katrina GALBRAITH
b
pl

[2-5]Jeanette GALBRAITH
b
pl
Neil PETERSEN
b
pl

Heidi PETERSEN
b
pl
Haig PETERSEN
b
pl
Kirsten PETERSEN
b
pl

9th Generation

10th Generation

[2-9]Shirley ROBINSON
b
pl
Dean M'BRIDE
b
pl

Amy M'BRIDE
b
pl

7th Generation

8th Generation

9th Generation

[2-5] Shirley POTHAN
b
pl
Donald HANSBY
b
pl

Wayne HANSBY
b
pl
Alison PEARCE
b
pl

Natalie HANSBY
b
pl
Kirsten HANSBY
b
pl

Kevin HANSBY
b
pl
Lorraine
b
pl

Lisa HANSBY
b
pl
Catherine HANSBY
b
pl

Donna HANSBY
b
pl
Peter DEVERAUX
b
pl

Evelyn DEVERAUX
b
pl
Kelly DEVERAUX
b
pl

Fiona HANSBY
b
pl

[2-5] Noel GALBRAITH
b
pl
Valda BUCHANAN
b
pl

Joanne GALBRAITH
b
pl

5th Generation

6th Generation

7th Generation

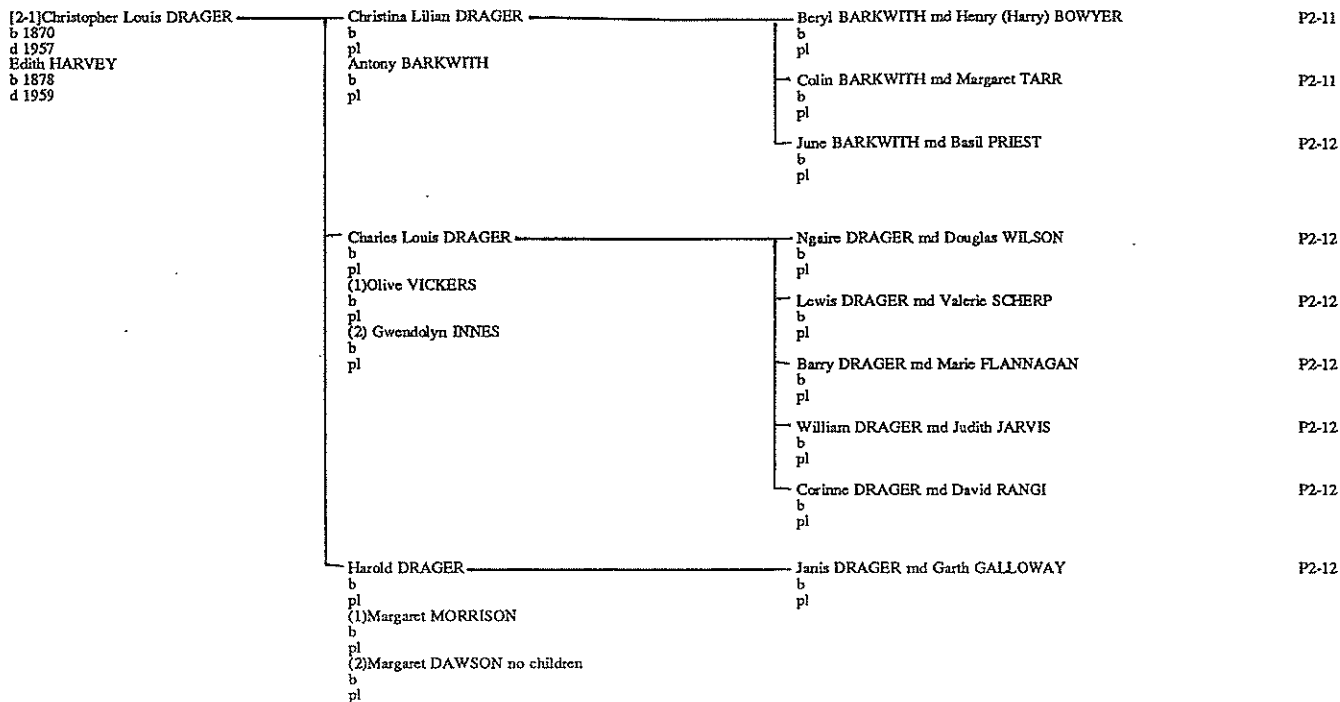

7th Generation

8th Generation

9th Generation

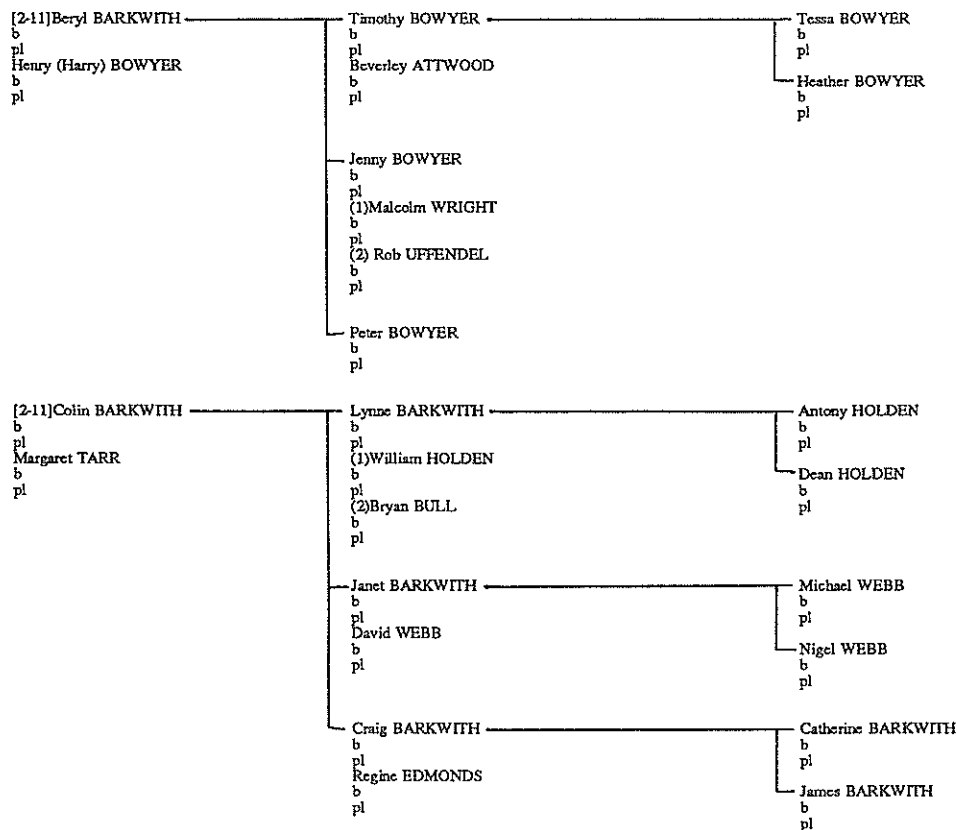

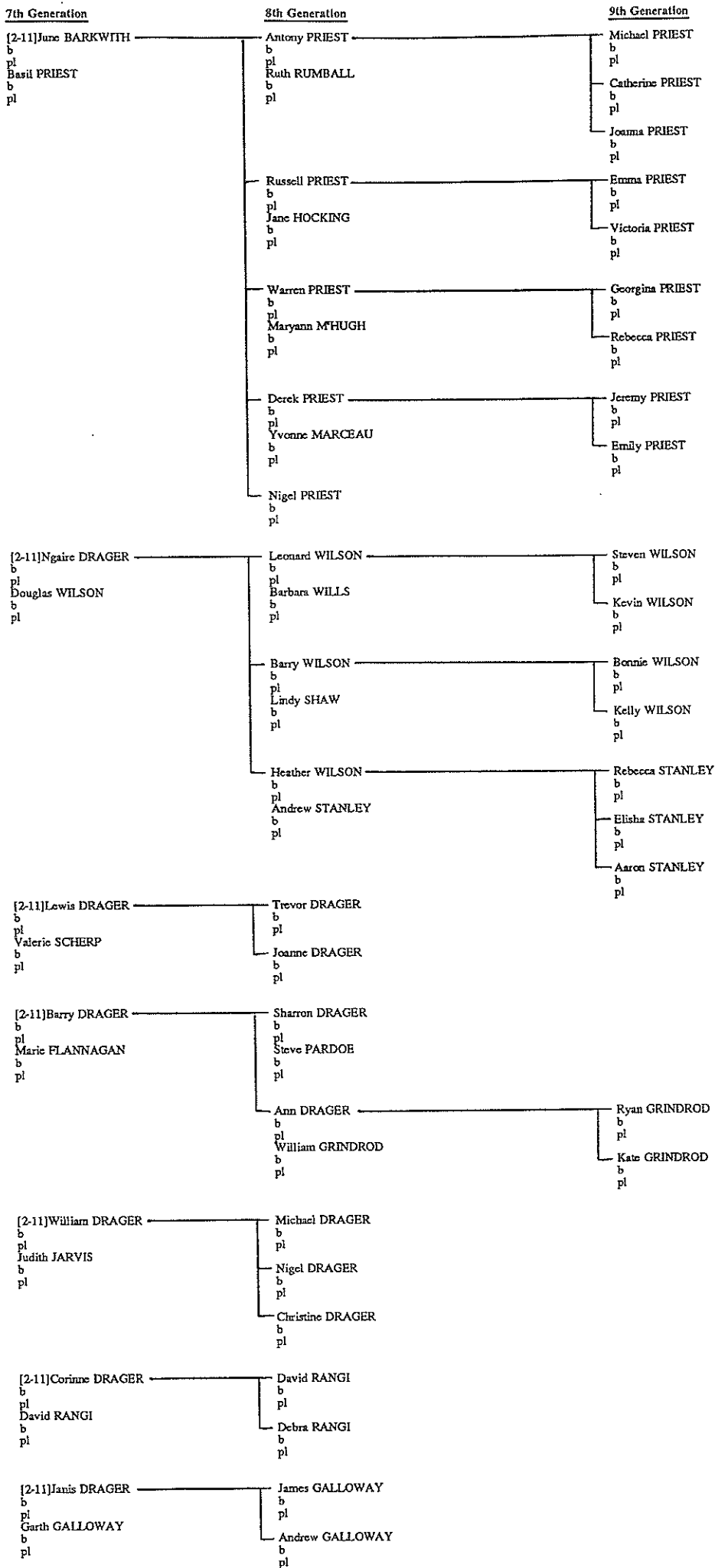

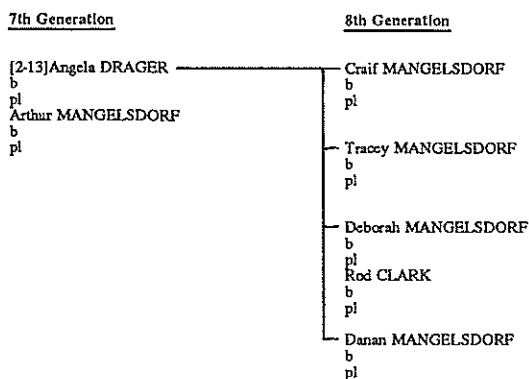
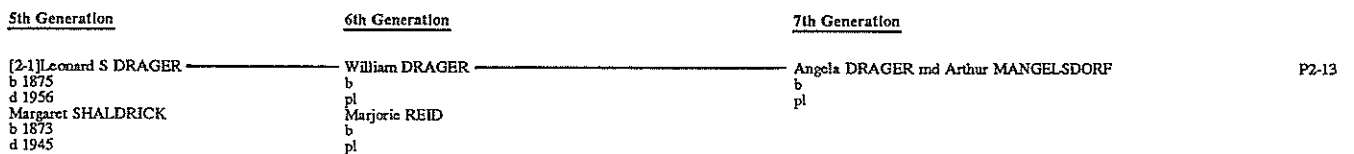
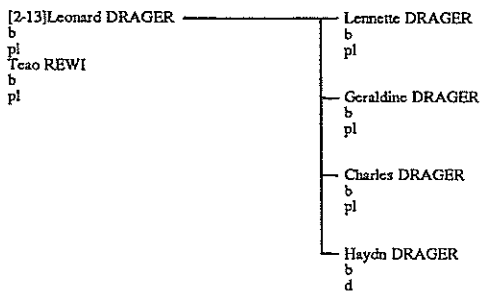
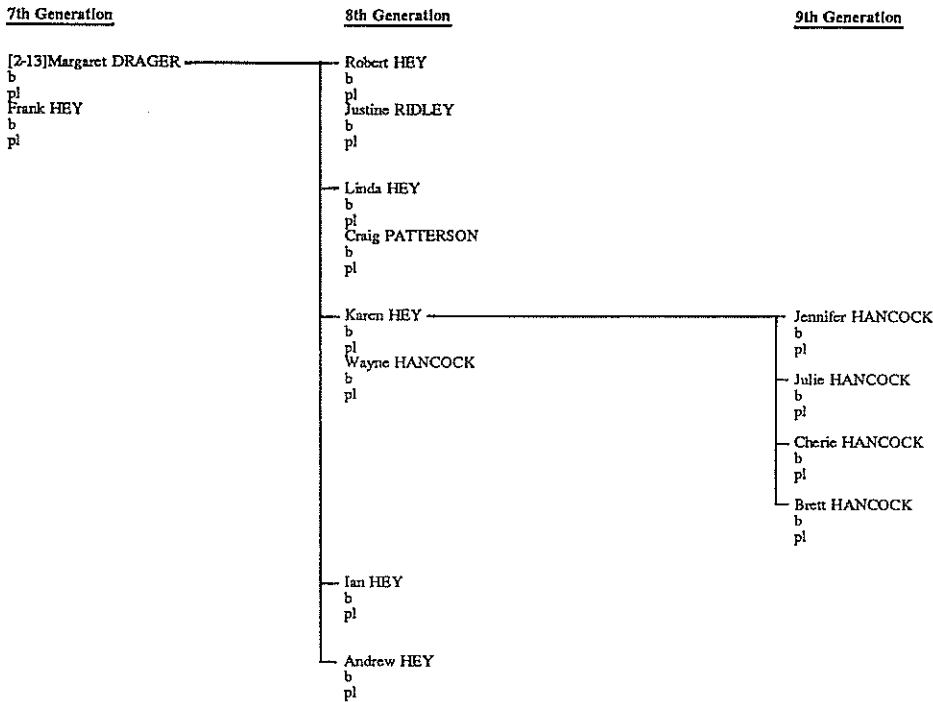
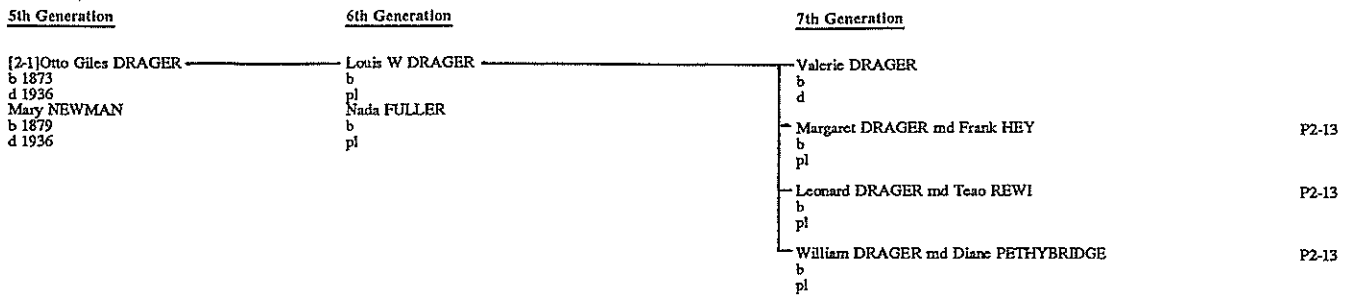

5th Generation

6th Generation

7th Generation

[2-1] Fritz A DRAGER
b 1878
d 1956
Edith COLLINS
b 1885
d 1945

Louis (Ted) DRAGER
b
pl
Ivy WORTH
b
pl

Robert DRAGER md Pamela LATIMER
b
pl

P2-14

Murray DRAGER
b
d

Marie DRAGER md William MURDOCH
b
pl

P2-14

Carole Foote (DRAGER) md Robert HARDY
b
pl

P2-14

Neta DRAGER
b
pl
William LYONS
b
pl

7th Generation

8th Generation

9th Generation

[2-14] Robert DRAGER
b
pl
Pamela LATIMER
b
pl

Brian DRAGER
b
pl
Denise CHAPMAN
b
pl

Mark DRAGER
b
pl

Karen DRAGER
b
pl

Lynsey DRAGER
b
pl
Warren JOHNSTON
b
pl

Helen JOHNSTON
b
pl

Craig JOHNSTON
b
pl

Ian DRAGER
b
pl
Sally ALDRIDGE
b
pl

Leona DRAGER
b
pl

[2-14] Marie DRAGER
b
pl
William MURDOCK
b
pl

Neil MURDOCK
b
pl

Trevor MURDOCK
b
pl

Stuart MURDOCK
b
pl

[2-14] Carole Foote (DRAGER)
b
pl
Robert HARDY
b
pl

Richard HARDY
b
pl

Raymond HARDY
b
pl

Grant HARDY
b
pl

5th Generation

6th Generation

7th Generation

[2-1] Winifred Rose DRAGER
 b 1880
 d 1915
 Thomas LLOYD
 b 1884
 d 1935

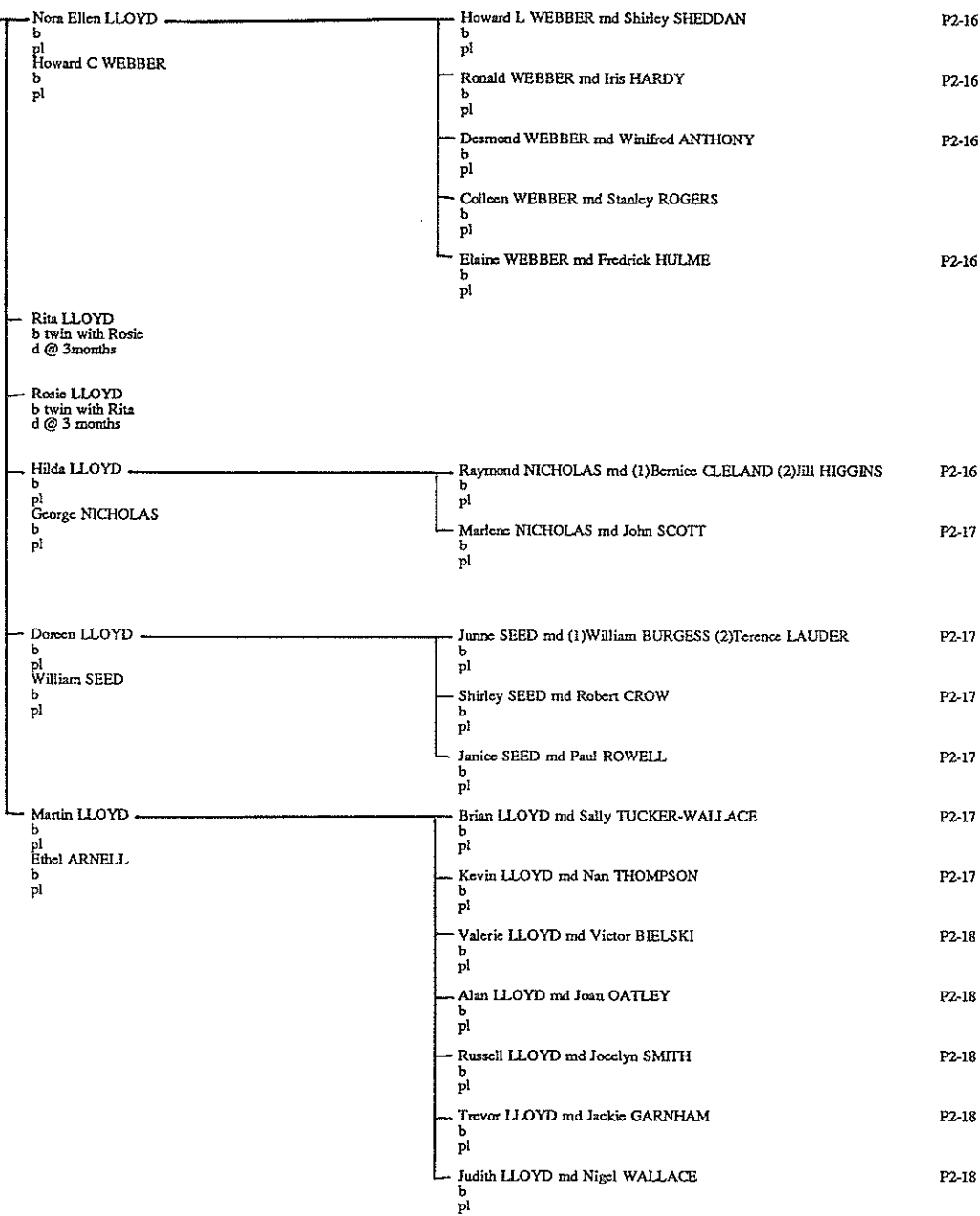

7th Generation

8th Generation

9th Generation

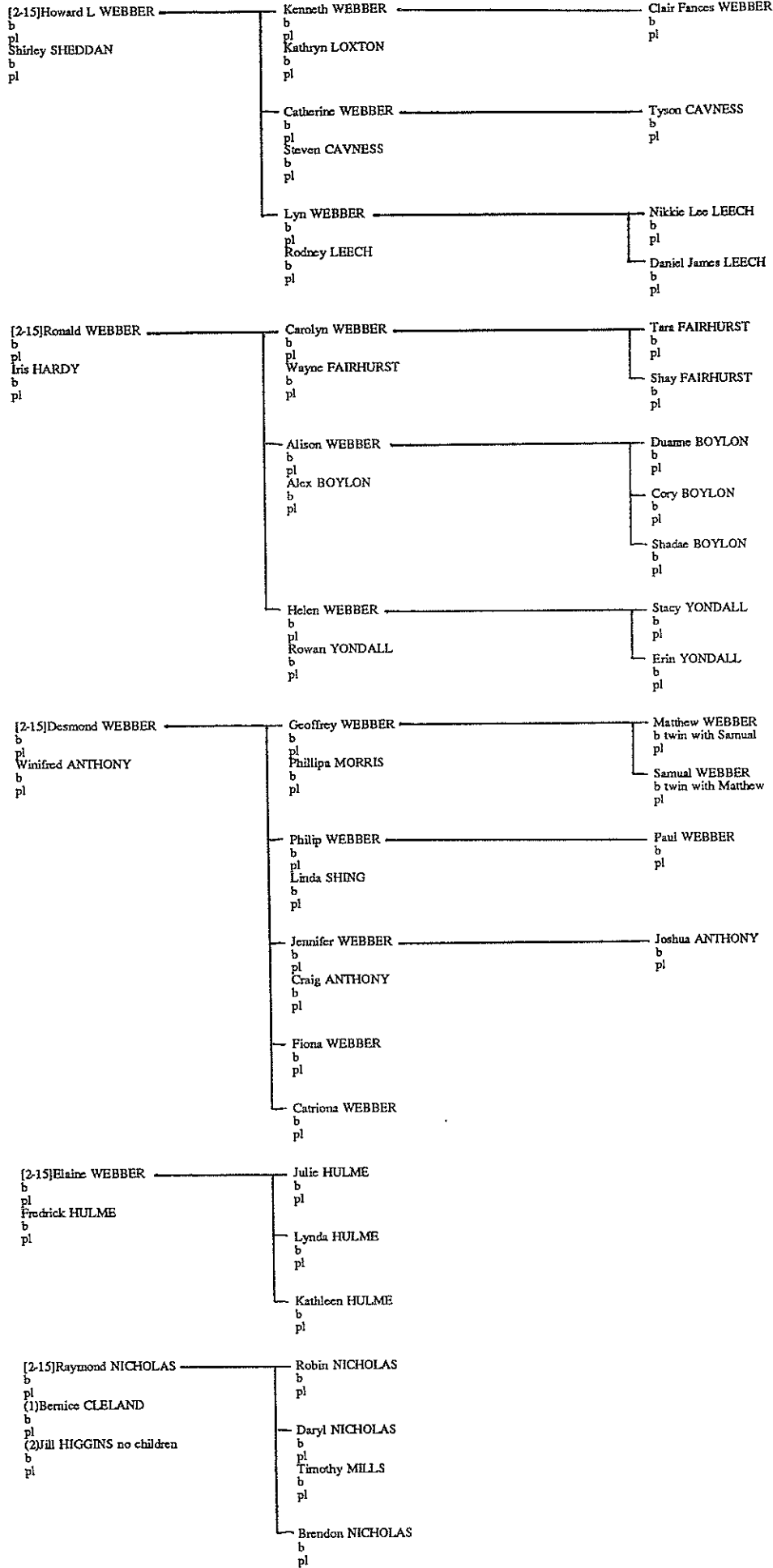

7th Generation

8th Generation

9th Generation

[2-15]Marlene NICHOLAS
b
pl
John SCOTT
b
pl

Wendy SCOTT
b
pl
David BARBER
b
pl
Sandra SCOTT
b
pl
Lcianne SCOTT
b
pl
Brenton MLEOD
b
pl

[2-15]Jumne SEED
b
pl
(1)William BURGESS
b
pl
(2)Terence LAUDER no children
b
pl

Sharron BURGESS
b
pl
Lyndon KENDALL
b
pl
Judith BURGESS
b
pl
Ross BURGESS
b
pl
Janice SUTTON
b
pl

Mark KENDALL
b
pl
Glen KENDALL
b
pl
Deon KENDALL
b
pl
Leyton KENDALL
b
pl

Leon BURGESS
b
pl

[2-15]Shirley SEED
b
pl
Robert Crow
b
pl

Deanne CROW
b
pl
Dorma CROW
b
pl
Toni CROW
b
pl
Jan-Maree CROW
b
pl

[2-15]Janice SEED
b
pl
Paul ROWELL
b
pl

Phillip ROWELL
b
pl
Wayne ROWELL
b
pl

[2-15]Brian LLOYD
b
pl
Sally TUCKER-WALLACE
b
pl

Martin LLOYD
b
pl
Daryl LLOYD
b
pl

[2-15]Kevin LLOYD
b
pl
Nan THOMPSON
b
pl

Brett LLOYD
b
pl
Patricia LLOYD
b
pl

7th Generation

8th Generation

[2-15]Valerie LLOYD
b
pl
Victor BIELSKI
b
pl

Jeannette BIELSKI
b
pl
Dean BIELSKI
b
pl
Anna BIELSKI
b
pl

[2-15]Alan LLOYD
b
pl
Joan OATLEY
b
pl

Nadia LLOYD
b
pl

[2-15]Russell LLOYD
b
pl
Jocelyn SMITH
b
pl

Michael LLOYD
b
pl
Stacy LLOYD
b
pl
Philop LLOYD
b
pl

[2-15]Trevor LLOYD
b
pl
Jackie GARNHAM
b
pl

Lisa LLOYD
b
pl
Annalene LLOYD
b
pl
Faith LLOYD
b
pl
Roger LLOYD
b
pl
Christine LLOYD
b
pl

[2-15]Judith LLOYD
b
pl
Nigel WALLACE
b
pl

Marie WALLACE
b
pl
David WALLACE
b
pl

SECTION 3

HELEN HAILES
&
JOHN TREVIS

3rd Generation

[1-1]Helen HAILES
b 20 Mar 1912 @ Mable, Worcester, UK
d 1896 Portefields Villa,Claines,Worc
John TREVIS 21 Feb 1832
b 1778 @ Claines, Worcester, UK
d 24Mar1858 Portefields Villa, Worcester

4th Generation

Helen TREVIS
b 17 Feb 1936 @ St George, Worcester, UK
d 1879 @ Brentford,London, Middlesex, UK
Charles Richard LONDON
b 30 April 1834 London
d

5th Generation

William Trevis LONDON md Amy Maria CARTER
b 1 July 1860 @ Hammersmith, London, UK
d 25 April 1903 Worton Rd Isleworth
Theresa Mary LONDON
b 4 April 1862 Hammersmith Middlesex UK
d
Cecilia Helen LONDON
b 1865 Bruges Belgium
d
Rose Marie LONDON md Humphery Charles HOLMAN
b 1867 Bruges Belgium
d
Charles Aloysius LONDON
b 1868 Bruges Belgium
d 23 May 1885 Wolverhampton Stafford UK
Agnes Marie LONDON md Charles Lawrence WILLIAMS
b 1868 Calais France
d Western Australia
Gertrude Mary LONDON md William Arthur CAMPBELL
b 15 April 1871 Donington Berkshire UK
d

P 3-1

5rd Generation

[3-1]William Trevis LONDON
b 1 July 1860 @ Hammersmith, London,UK
d 25 Apr 1903 Isleworth, Middlesex, UK
Amy Maria CARTER 13Jun1883 St Johns
b 7-9-1861 45London RdSouthwarkSurrey
d 14-2-1925 @Hanwell Hosp.,Southall,UK

6th Generation

Cyril Trevis LONDON
b 1874
d possibly died South Africa NI
Edwin Charles LONDON
b 1888
d 4 Jan 1936 @ London UK b. Streatham Park
Cecil Frederick William LONDON
b 2 Sep 1891 @ Kensington, London,UK
d 1968 @ Sydney, Australia
Gretchen Lilian Amelia PERRY 14-8-1913 St Leonards Aus.
b 8 Sep 1892 East Melbourne VIC Australia
d 26 Aug 1967 Sydney NSW Australia

7th Generation

Richard Noel LONDON md Christina Peace MURPHY 2Oct52 Sydney
b 20 Dec 1912 Sydney NSW Australia
d 4 May 1980 Pymble NSW Australia
Cyril Trevis LONDON md Zena Theresa WALL 17Dec37 Bondi
b 13 May 1914 Sydney NSW Australia
d 13 July 1974 Caves Beach NSW Australia
Fredrick Cecil LONDON md Dorothy Jean PECKMAN
b 2 Sep 1917 Redfern NSW Australia
pl
June Margaret LONDON md Leo YOUNG 3Aug46 Woolahra
b 21 May 1929 Sydney NSW Australia
d 1961 Wahroonga NSW Australia

P 3-1

P 3-1

P 3-1

7th Generation

[3-1]Richard Noel LONDON
b 20 Dec 1912 Sydney NSW Australia
d 4 May 1980 Pymble NSW Australia
Christina Peace MURPHY
b 11 Nov 1918 Geelong VIC Australia
pl

8th Generation

Stephen LONDON
b 8 May 1953 Sydney Australia
pl
Pheola KITAS
b 18 June 1955
pl
Mark LONDON
b 13 Aug 1956 Sydney Australia
pl
Sharon BISHOP 6 Feb 1988 Sydney
b
pl

9th Generation

Theo LONDON
b 10 Jan 1989
pl

[3-1] Cyril Trevis LONDON
b 13 May 1914 Sydney NSW Australia
d 13 July 1974 Caves Beach NSW
Zena Theresa WALL
b 27 Nov 1915
pl

Alan LONDON
b
pl
Christine PAULSON Gordon NSW
b
pl
David LONDON
b
pl

Anita LONDON
b 15 March 1970 Sydney NSW Australia
pl
Michael LONDON
b 28 Dec 1971 Sydney NSW Australia
pl

[3-1]Fredrick Cecil LONDON
b 2 Sep 1917 @ Redfern,NSW, Australia
pl
Dorothy Jean PECKMAN 25-10-41 Sydney
b 2 Aug 1921 Broken Hill NSW Australia
pl

Suzanne Gretchen LONDON
b 25 Jan 1946 Sydney Australia
pl Alstonville NSW Australia
Hubertus Nicolaas Maria WARMERDAM 24-1-1966Edinburgh
b 14 July 1938 Bloemendaal, The Netherlands
pl

Ian Landon WARMERDAM
b 30 Jan 1968 Manly Sydney Aust.
pl Eastwood NSW
Nicole Suzanne WARMERDAM
b 15 June 1971 Seven Hills Sydney Aust.
pl Alstonville NSW
David Landon WARMERDAM
b 24 Jul 1972 Hornsby Sydney Aust.
pl Bondi Beach NSW

SECTION 4

EDWARD HAILES
&
ELIZABETH ALBOT

3rd Generation

4th Generation

5th Generation

[1-1]Edward HAILES
b 28 Dec 1813
d
Elizabeth ALBOT
b
d

11 Children

Agnus HAILES
b 1842 @ Long Birch
d 1916
Thomas Napoleon LLOYD 1861
b 1836
d 1909

Aloysius Joseph (Loucy) LLOYD md A GRANT P4-2
b 1862
d 1908

Edward Richard (Eddie) LLOYD
b 1863
d 1932

Edith Mary (Didda or Edie) LLOYD Professed 1887
b 1864
d 1856

Fredrick Joseph (Freddie) LLOYD md Lilian EAST P4-2
b 1866
d 1944

Francis Thomas (Frank) LLOYD Ordained 1891
b 1867
d 1903

Bernard John (barnie)LLOYD
b 1868
d

Mary Clare LLOYD Professed 1894
b 1870
d 1950

Thomas Austin LLOYD
b 1871
d 1910

Charles Albot (Charlie) LLOYD md Clementine CHEESEMAN P4-2
b 1873
d

Agnus Hailes LLOYD md M. Baron von BAUER BORGEHN
b 1874
d 1944

Joseph Edmond (Joe) LLOYD
b 1875
d

Veronica Mary Annette (Sissie) LLOYD
b 1877
d 1951

John LLOYD
b 1877
d

John Stephen (Jack) LLOYD
b 1879
pl

Augustine (Austin) LLOYD
b 1881
d

Stanislaus Gabriel LLOYD
b 1883
pl

George HAILES
b
d
A GILES
b
d

Mary HAILES
b
d

Elizabeth HAILES
b
d

Edward HAILES
b
d

5th Generation

6th Generation

7th Generation

[4-1]Aloysius Joseph LLOYD
b 1862
d 1908
A GRANT 1899
b
d

Dame Mary LLOYD
b
pl
Prof John CHESHIRE
b
pl

Captain Frances LLOYD RN
b 1900
pl

[4-1]Fredrick Joseph LLOYD
b 1866
d 1844
Lillian EAST
b
d

Gerald LLOYD
b 1902
d 1978
Gertrude RANKIN
b
d

Pauline Agnus LLOYD md Terance COMERFORD 1949
b 1928
d

John Bernard LLOYD md Margaret Ann MARSH 1955
b 1930
pl

P4-3

Mary Geraldine LLOYD
b 1903
d 1905

Agnus Lillian LLOYD
b 1905
pl
James DAY
b
pl

Mary DAY
b
pl

Geraldine DAY
b
pl

Christopher DAY

Mary Josephene LLOYD
b 1907
pl
Joseph SANDLER
b
d 1969

Ann SANDLER
b
pl

Peter SANDLER
b
pl

David SANDLER
b
pl

John SANDLER
b
pl

Paul SANDLER
b
pl

Richard SANDLER

Charles Bernard LLOYD
b 1920
pl
Diane Evelyn Jean TODD
b 1923
pl

Susan Bernadette LLOYD md Anthony Colin DAVIS
b 1945
pl

P4-3

Patricia Mary LLOYD md Keith Leslie BOWIE
b 1947
pl

P4-3

Adrian Fredrick LLOYD md Sheila Joan SALVS
b 1949
pl

P4-3

[4-1]Charles Albot (Charlie) LLOYD
b 1873
d
Clemantine CHEESEMAN
b
d

Edith LLOYD
b 1903
d 1968

Margaret LLOYD
b
pl

7th Generation

8th Generation

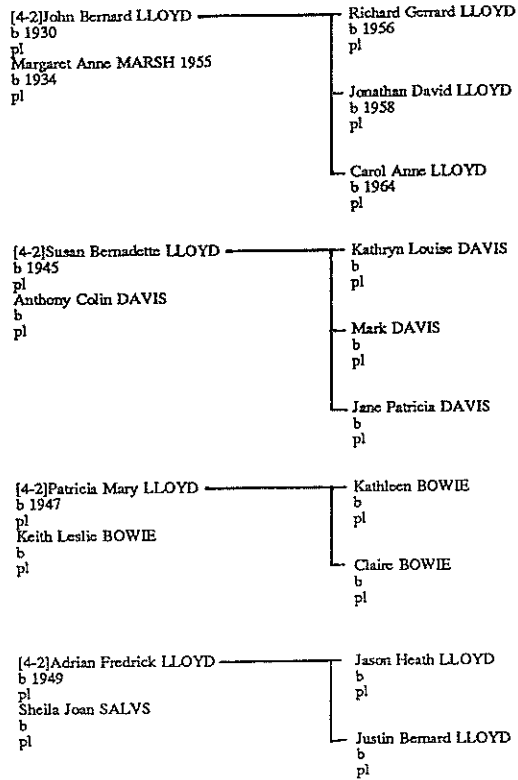

SECTION 5

WALTER MARY HAILES & FRANCES ANN WARD

Walter and Frances arrived in New Zealand from Staffordshire aboard the "Edward Thornhill", A 520 ton barque under Captain Reynold which left from London and made the trip in 120 days arriving in Nelson on 2 October 1862. On board with them were their six children, Felix, Walter, Edward, Joseph Mary and Winifred, Walters younger brother George, and George's three surviving children, Walter's niece Helen Giles and two Ward cousins.

After spending two years the Wairau in Marlborough the family moved to Kaikoura where Walter farmed and contracted. He was engaged in road making for the Provincial Government with his sons and was paid for the labour in land.

3rd Generation

4th Generation

5th Generation

[1-1]Walter Mary HAILES
 b 14-3-1818 @ Marnble Worcestershire England
 d 15-5-1881 @ Kohai, Kaikoura
 Frances Ann WARD 1848 Henley-in-Arden
 b 12 Sept 1821 Tixhalli UK
 d 10 Jan 1900
 Came to New Zealand in 1862
 on Edward Thornhall with brother,
 George and niece Helen Giles

Felix HAILES
 b
 d
 Poly BOLTON (2nd Cos)
 b
 d

No Children

Walter Mary HAILES (1)
 b
 d 19-1-1919 @ Balfour
 (1)Mary Francis DWYER 10-4-1893 @ Riverton, Otago
 b approx 1866 @ Frankton, Lake County
 d 31-3-1906 @ Cattle Flat, Balfour
 (2)Bella DUNNE
 b
 d

Walter Philip Mary(Phil) HAILES md (1)Cath M'CARTNEY(2)Jane SHAW P5-2
 b 9-7-1902 @ Dunedin
 d @ Palmerston North
 Frank John Hailes md (1)Mary SENIOR (2)Ethel P5-4
 b 21-2-1904 @ Dunedin
 d
 Ellen Mary (Mary) HAILES md Clive PALMER P5-5
 b 14-1-1906 @ Kirkland Hill, Roslyn
 d

Edward HAILES
 b
 d
 Nora COAKLEY
 b
 d

Edward C J M HAILES md Florence Leonard (Floss) HAILES (2nd Cos) P5-7
 b 1891
 d 7 July 1955 age 64
 Maggie HAILES md Jack MACKLE P5-8
 b
 d
 Frances Hailes md Leo GAFFNAY P5-8
 b
 d
 Cornelius (Con) HAILES md Elizabeth COUGHLAN P5-9
 b
 d
 Walter HAILES md (1)Mary INDER (2)
 b
 d

Joseph M HAILES
 b
 d
 (1)Mary Ellen TATE
 b approx 1865
 d 10 Aug 1890 age 25 Kaikoura
 (2)HUTCHENSON
 b
 d

Tate James Walter HAILES
 b
 d 13 Feb 1948 age 59
 Felix Joseph HAILES md Bernice (Bobs) PARSONS P5-11
 b
 d 27 Jan 1950 age 60

Mary HAILES
 b
 d
 Charles WARD
 b
 d

Amy WARD
 b
 d
 Frank WARD
 b
 d
 Evelyne WARD
 b
 d
 Ivy WARD
 b
 d
 Winifred WARD
 b
 d
 Vera WARD
 b
 d

Winifred HAILES
 b
 d
 Aloysius WARD
 b
 d

No Children

Bernard HAILES (Bachelor)
 b
 d

Richard Henry Mary HAILES
 b 2-7-1864 @ Blenheim
 d 29-5-1948 @ Kamo, North Auckland
 Agnes Norma BROWN 12-1-1901 @ Wellington
 b approx 1874 @ Wanganui
 d 6 Feb 1927 age 53

Norma Agnes Mary HAILES md Leo HODGSON P5-12
 b 16-10-1901 @ Kaikoura
 d @ Papakura
 Ronald Joseph HAILES md Olive Mary PATRICK P5-12
 b 17 May 1903 @ Kaikoura
 d 9 Sep 1960 @ Kamo
 Richard Edmond (Frank) HAILES md Maud McMULLAN
 b 16 Sep 1904 @ Kaikoura
 d 1 April 1951 @ Maungatapere
 Vincent Edward HAILES md Mary MURRAY
 b 19 July 1906 @ Kaikoura
 d @ Papakura
 Bernard Joseph HAILES md Nellie SLAKO P5-12
 b 17 July 1908 @ Kaikoura
 d
 Mary Elizabeth (Betty) HAILES md Ted GULLIVER P5-12
 b 16 Nov 1912
 d @ Christchurch
 Joseph Walter Hailes md Nell O'BRIEN P5-12
 b 10 Dec 1913
 d 26 March 1978 @ Maungatapere
 Walter Edward HAILES md Adele HARRIS P5-14
 b 16 June 1916
 d @ Maungatapere

5th Generation

6th Generation

7th Generation

[5-1] Walter Philip Mary (Phil) HAILES
 b 9 July 1902 Dunedin
 d March 1972 Palmerston North
 (1) Elizabeth Catherine (Cath) M'CARTNEY
 b 1906
 d 13 April 1982 age 76 Gore
 (2) Jane SHAW 1944 @ Temuka
 b 13 March 1911 Orton
 d 7 Jan 1979 Foxton

(1) Walter Francis Thomas HAILES
 b
 d
 Eileen HANLEY
 b
 d 16 July 1984 age 52

(1) Francis (Frank) John Nathouiel HAILES
 b 5 Dec 1926 @ Gore
 d
 Maureen MACPHERSON
 b 6 Feb 1928
 pl Dunedin 1992

(2) George Philip HAILES
 b 23-5-1945
 pl Havelock North 1992
 Raewyn STRINGER
 b
 pl Havelock North 1992

(2) Sara Jane HAILES
 b 11-11-1946
 pl Hastings NZ 1992
 Ray SLAVIN @ Taita
 b
 pl Hastings NZ 1992

(2) Russell Stephen HAILES
 b 9-2-1949 @ Temuka NZ
 pl Lower Hutt 1992
 Margaret Ann ISAACS 5-2-1972 @ Lower Hutt
 b 3-11-1950 @ Plymouth UK
 pl Lower Hutt

(2) Philip John HAILES
 b 21-10-1951
 pl Foxton NZ

Carina HAILES mnd Alan KING
 b
 pl Riverton 1992

Eileen HAILES mnd Chris WILSON
 b
 pl

Mary HAILES mnd Michael BURKE
 b 6 Feb 1951 @ Invercargill
 pl Invercargill 1992

Anita HAILES mnd Warren JORDAN
 b 1 March 1952 @ Gore
 pl Dunedin 1992

Brian HAILES mnd Jane WIELY
 b 24 Feb 1954 @ Milton
 pl Dunedin 1992

Ian HAILES mnd Edel FOGARTY
 b 20 May 1955 @ Balclutha
 pl Perth Aust 1992

Patrick HAILES
 b 2 Sep 1957 @ Balclutha
 d

Therese HAILES mnd Paul WILSON
 b 29 Nov 1959 @ Balclutha
 pl Dunedin 1992

Monica HAILES
 b 15 Oct 1961 @ Balclutha
 pl Melbourne Aust 1992

Pauline HAILES mnd Michael CAMPBELL
 b 7 Oct 1963 @ Lawrence
 pl Dunedin 1992

Daniel (Danny) HAILES Sarah MATHERSON
 b 17 Oct 1966 @ Lawrence
 pl Invercargill 1992

David HAILES
 b 17 Dec 1969 @ Dunedin
 pl Dunedin 1992

Louise HAILES
 b 1 July 1971 @ Dunedin
 pl UK 1992

Conrad HAILES
 b 12-10-1974
 pl Havelock North NZ 1992

Imelda Jane HAILES
 b 13-7-1977
 pl Havelock North NZ 1992

Martin Ray SLAVIN
 b 30-3-1970
 pl Christchurch NZ 1992

Blair Maynard SLAVIN
 b 25-9-1972
 pl Hasting NZ 1992

Callum SLAVIN
 b 8-8-1974
 pl Hastings NZ 1992

Stephen Russell HAILES
 b 25-3-1977 @ Lower Hutt NZ
 PL Lower Hutt 1992

Michael James HAILES
 b 22-12-1978 @ Lower Hutt
 pl Lower Hutt 1992

Nicole

*d 29-10-2003
Lower Hutt*

*d 18-1-1999
Hastings*

*Dylan James
b 14-12-2001*

P5-3

P5-3

P5-3

P5-3

P5-3

P5-3

P5-3

P5-3

7th Generation

8th Generation

[5-2]Carina HAILES
b
pl Riverton 1992
Alan KINGIPOTIKI
b
pl Riverton 1992

Tane KINGIPOTIKI
b
pl Riverton 1992
Violet KINGIPOTIKI
b
pl Riverton 1992

[5-2]Eileen HAILES
b
pl
Chris WILSON
b
pl

Daniel WILSON
b
pl
Rosemary WILSON
b
pl

[5-2]Mary HAILES
b 6 Feb 1951 @ Invercargill
pl Invercargill 1 1992
Michael BURKE
b
pl Blenheim 1992

Imelda BURKE
b
pl Invercargill 1992
Siobhan BURKE
b
pl Invercargill 1992
Bridgette BURKE
b
pl Invercargill 1992

[5-2]Anita HAILES
b 1 March 1952 @ Gore
pl Dunedin 1992
Warren JORDAN
b
pl Dunedin 1992

Mathew JORDAN
b twin with Zeta
pl Dunedin 1992
Zeta JORDAN
b twin with Mathew
pl Dunedin 1992

[5-2]Brian HAILES
b 24 Feb 1954 @ Milton
pl Dunedin 1992
Jane WIELY
b
pl Dunedin 1992

Lauren HAILES
b
pl Dunedin 1992
Dominic HAILES
b
pl Dunedin 1992
Cassie HAILES
b
pl Dunedin 1992

Henry 96

[5-2]Ian HAILES
b 20 May @ Balclutha
pl Perth, Australia
Eddi FOGARTY
b
pl

Kieran HAILES
b
pl
Dylon HAILES
b
pl
Kathlyn HAILES
b
pl

[5-2]Therese HAILES
b 29 Nov 1959 @ Balclutha
pl Dunedin 1992
Paul WILSON
b
pl Dunedin 1992

Simon WILSON
b
pl Dunedin 1992
Anna WILSON
b
pl Dunedin 1992
Edward Wilson
b
pl Dunedin 1992
Patrick Michael WILSON
b April 1992
pl Dunedin

[5-2]Daniel (Danny) HAILES
b 17 Oct 1966 @ Lawrence
pl Invercargill
Sarah MATHERSON
b
pl Invercargill

Oliver Francis Gibson HAILES
b 20 Aug 1992 @ Invercargill
pl Invercargill

5th Generation

6th Generation

7th Generation

[5-1] Frank HAILES
b 21-2-1904
d
(1) Mary SENIOR
b
d
(2) Ethel *McICEN*
b 14/11/1904
d

(1) Mary HAILES
b
d
Roy RANKIN
b
d

Keith RANKIN
b
d
Alan RANKIN
b
d
Murray RANKIN
b
d

John HAILES
b
d
Cecilia TOBIN
b
d

Stephen HAILES
b
pl
Julia HAILES
b
pl
Christine HAILES
b
pl
Deborah HAILES
b
pl
Francis HAILES
b
pl
David HAILES
b
pl
Peter HAILES
b
pl

5th Generation

6th Generation

7th Generation

[5-1] Mary HAILES
 b 14-1-1906
 d 18-6-1963 @ Whangarei
 Clive PALMER
 b
 pl Whangarei

Noeline PALMER
 b 6-11-1929
 pl Waipu, Northland
 Walter W DRAPER
 b
 pl Waipu, Northland

Graham Walter DRAPER md Judy GOODRICK
 b 16-5-1950
 pl Caloundra, Queensland, Australia 1992

P5-6

Lorraine Noeline DRAPER md Graham BICKERS
 b 3-12-1951
 pl Puni, Auckland 1992

P5-6

Robert Clive DRAPER md Jill
 b 28-7-1955
 pl Queensland, Australia 1992

P5-6

Catherine Carol DRAPER
 b 8-2-1957
 pl Waipau, Northland 1992

P5-6

Mark Patrick DRAPER md Catherine ARMSTRONG
 b 21-4-1958
 pl Kamo, Northland 1992

P5-6

John Craig Thomas DRAPER
 b 12-9-1960
 pl Sydney, Australia 1992

Paula Mary DRAPER md Chris
 b 19-6-1969
 pl Whangarei

P5-6

Clive PALMER
 b
 pl
 Marie RINETT-CARNAC
 b
 pl

Brett PALMER
 b
 pl

Vicky PALMER
 b
 pl

Gregory PALMER
 b
 pl

Jacky-Ellen PALMER
 b
 pl

June PALMER
 b
 pl

Neville PALMER
 b
 pl
 Gloria HANSEN
 b
 pl

Karen PALMER
 b
 pl

Christine PALMER
 b
 pl

Cindy PALMER
 b
 pl

Linton PALMER
 b
 pl

Eden PALMER
 b
 pl

Max PALMER
 b
 pl
 Maree SCULPHIR
 b
 pl

Russell PALMER
 b
 pl

Patricia PALMER
 b
 pl

Joanne PALMER
 b
 pl

Sandra PALMER
 b
 pl

Pamela PALMER
 b
 pl
 Jake SHAW
 b
 pl

Kerry SHAW md Michael
 b
 pl

Peter SHAW md Sandra
 b
 pl

Lynette PALMER
 b
 pl
 Graham NEELEY
 b
 pl

Andrea NEELEY
 b
 pl

Fraser NEELEY
 b
 pl

Rodney PALMER
 b
 pl
 Dilys BRYANT
 b
 pl

Michael PALMER
 b
 pl

Catherine PALMER
 b
 pl

Susan PALMER
 b
 pl

7th Generation

8th Generation

[5-5]Graham Walter HAILES
b 16-5-1960
pl
Judy GOODRICK
b
pl

Clint HAILES
b 30-5-1977
pl
Luke HAILES
b 8-5-1981
pl
Holly HAILES
b 21-11-1984
pl

[5-5]Lorraine Noeline DRAPER
b 3-12-1951
pl
Graham BICKERS
b
pl

Mathew BICKERS
b 1-9-1973
pl
Nathan BICKERS
b 21-12-1975
pl
Angela Mary BICKERS
b 13-2-1979
pl

[5-5]Robert Clive DRAPER
b 28-7-1955
pl
Jill
b
pl

Demelza DRAPER
b 1-5-1982
pl
Joshua DRAPER
b 8-4-1984
pl
Jessica DRAPER
b 30-6-1989
pl

[5-5]Catherine Carol DRAPER
b 8-2-1957
pl

Lydia DRAPER
b 18-1-1989
pl

*Garth Walter Christensen
b. 5 Jan 93*

[5-5]Mark Patrick DRAPER
b 21-4-1958
pl
Catherine ARMSTRONG
b
pl

Caroline DRAPER
b 18-8-1981
pl
Katie DRAPER
b 22-10-1983
pl
Laura DRAPER
b 8-4-1991
pl

[5-5]Paula Mary DRAPER
b 19-6-1969
pl
Chris
b
pl

Rachael Ellen DRAPER
b
pl

5th Generation

[5-1] Edward Cornelius Joseph Mary HAILES
b 1891
d 7 July 1955 West Takaka Catholic
Florence (Floss) Leonard HAILES(2nd Cos)
b 1886
d 21 Feb 1964 West Takaka Catholic

6th Generation

Mary HAILES
b
d
Terry RALFE
b
d

7th Generation

Desmond RALFE
b
pl
Mary-Anne RALFE
b
pl
Patrick RALFE
b
pl
Jane RALFE
b
pl
Tim RALFE
b
pl
Mathew RALFE
b
pl

Nora HAILES
b
pl
Ralph HOPE
b
pl

Paul HOPE
b
pl
Anthony HOPE
b
pl
Christopher HOPE
b
pl
Marie HOPE
b
pl
Mark HOPE
b
pl
Nicholas HOPE
b
d
Sarah HOPE
b
pl
Damien HOPE
b
d

Margaret HAILES (Spinster)
b
pl Nelson

George HAILES
b 24-9-1924
d 19 Sept 1993 @ Lower Hutt
Ngaere BRENNAN
b 3-11-1928
pl Lower Hutt 1992

Mark HAILES
b 17-4-1958
pl Lower HUTT 1992
Erin HAILES md Eddie TRYBULA
b 7-3-1960
pl
Catherine HAILES
b 22-4-1961 @ Lower Hutt
d 23-9-1963 @ Lower Hutt
Gabrielle HAILES md Gerard TULLY
b 10-5-1964
pl
Mary HAILES
b 25-10-1965
pl

P5-7

Jack

Josephine HAILES
b
d
Lindsay SPARROW
b
pl

Bruce SPARROW
b
pl
Stephen SPARROW
b
d
Joanne SPARROW
b
pl
Martin SPARROW
b
pl
Mereta SPARROW
b
pl

7th Generation

[5-7] Erin HAILES
b 7-3-1960
pl
Eddie TRYBULA
b
pl

8th Generation

Luke TRYBULA
b 1-10-1981
pl
Joshua TRYBULA
b 14-7-1987
pl

5th Generation

6th Generation

7th Generation

[5-1]Maggie HAILES
b
d
Jack MACKLE
b
d

Eddie MACKLE
b
pl
Mary WINTER
b
pl

Marie MACKLE
b
pl
Austin MACKLE
b
pl

Kevin MACKLE
b
pl
Ethel GARRETT
b
pl

Marilyn MACKLE
b
pl
Frances MACKLE
b
pl
Edward MACKLE
b
pl

Brian MACKLE
b
pl
Helen GOODMAN
b
pl

John MACKLE
b
pl
Pat MACKLE
b
pl
Beverly MACKLE
b
pl

Nora MACKLE
b
pl
Cecil STIVIN
b
pl

Patricia MACKLE
b
pl
Vincent O'CONNOR
b
pl

Denis O'CONNOR
b
pl
Mark O'CONNOR
b
pl
Peter O'CONNOR
b
pl

Walter MACKLE
b
pl
Ngairie INWOOD
b
pl

Margaret MACKLE
b
pl
Christine MACKLE
b
pl

[5-1]Frances HAILES
b
d
Leo GAFFNAY
b
d

Michael GAFFNAY
b
pl Temuka 1992
Brenda WATERS
b
pl

Leo GAFFNAY
b
pl
William GAFFNAY md Mary M'CABE
b
pl
David GAFFNAY
b
pl
Anne GAFFNAY
b
pl

Frances GAFFNAY Sister Frances Sister of St. Joseph
b
pl Otatau, Western Southland 1992

Margaret GAFFNAY
b
pl
Patrick M'CABE
b
pl

Maryanne M'CABE
b
pl

5th Generation

6th Generation

7th Generation

[5-1] Cornelius (Con) Joseph HAILES
 b
 d 23 Dec 1978 age 82
 Elizabeth COUGHLAN
 b
 d 2 Jan 1961

Patricia HAILES
 b
 pl
 Daniel (Dan) MULQUEEN
 b
 pl

Kevin MULQUEEN
 b
 pl
 Anthony MULQUEEN
 b
 pl
 Mary MULQUEEN
 b
 pl
 Ellen MULQUEEN
 b
 pl
 Anita MULQUEEN
 b
 pl

Edward HAILES
 b
 pl Balfour 1992
 Anita FLYNN
 b
 pl Balfour 1992

Paul HAILES
 b
 pl Balfour 1992

Kevin HAILES
 b 23 Aug 1927
 pl Balfour
 Dorothy MOYNIHAN
 b 26 June 1931
 pl Balfour

Peter Alexander HAILES
 b Lumsden
 d drowned 20 Oct 1962 age 8 @ Balfour
 Christopher HAILES
 b 7 Mar 1956 @ Lumsden
 pl Terrigal, Australia
 Ronald HAILES md Donna COURNAME
 b 29 Jun 1960 @ Lumsden
 pl Balfour 1992
 Anne HAILES m Rex Duncan - John William Duncan
 b 6 Dec 1962 @ Lumsden
 pl Melbourne, Australia
 Rosemarie HAILES
 b 19 Apr 1966 @ Lumsden
 pl Stewart Island, NZ
 Michael HAILES
 b 24 Sep 1970 @ Lumsden
 pl Balfour 1992

P5-10

Ruby 26th 1960

Leslie HAILES
 b
 pl
 Patricia CODY
 b
 pl

Angela HAILES
 b
 pl
 John-Leslie HAILES
 b
 d 9 November 1991

Marita HAILES
 b 14 Feb 1933
 pl Winton
 Alexander MOYNIHAN
 b 7 May 1926
 pl Winton

John MOYNIHAN md (1) (2) Jenny Unterown
 b 12 Apr 1956
 pl Invercargill
 Paul MOYNIHAN md unknown
 b 3 Mar 1958
 pl Invercargill
 Terence MOYNIHAN md Shelly TEMPLETON
 b 11 Dec 1959
 pl Mt Isa, Australia
 Clare MOYNIHAN md Bernie ZYSKOWSKI
 b 17 Aug 1961
 pl Invercargill
 Alexander MOYNIHAN
 b 28 Jun 1963
 pl Sydney, Australia
 Mark MOYNIHAN
 b 7 Feb 1966
 pl Los Angeles, USA
 Julie MOYNIHAN
 b 6 Jul 1968
 pl Invercargill

P 5-10

P 5-10

P 5-10

P 5-10

Mc Dowell

Karen Telfer

7th Generation

8th Generation

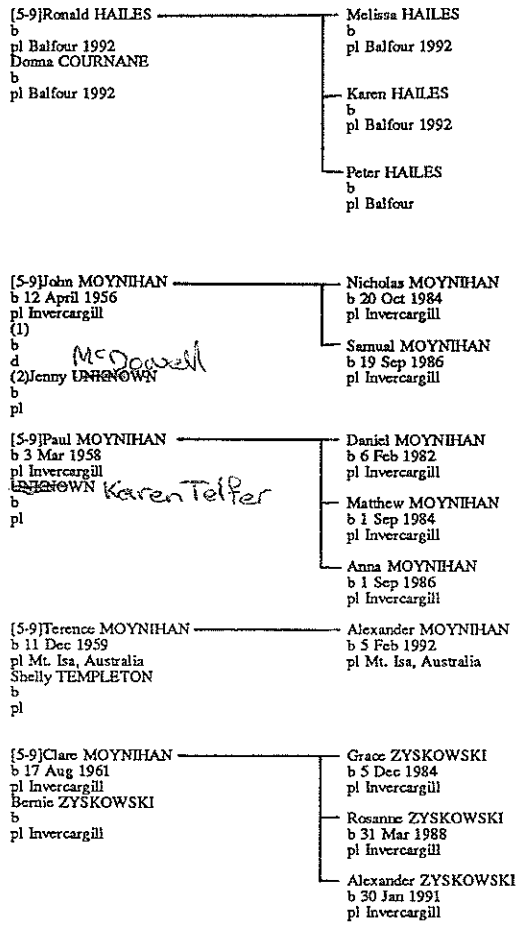

5th Generation

6th Generation

7th Generation

[5-1] Felix Joseph HAILES 21676 1st NZEF
 b
 d 27 Jan 1950 age 60 Kaikoura
 Bernice (Bobs) PARSONS (3rd Cos.)
 b
 d 10 Nov 1970 age 70 Kaikoura

Tom HAILES
 b
 pl
 Kathleen Patricia ARCHER
 b
 pl

Susan HAILES mtd James DUNCAN
 b
 pl
 James HAILES
 b
 pl
 Philippa HAILES
 b
 pl
 John HAILES
 b
 pl
 Gerard HAILES
 b
 pl
 Richard HAILES
 b
 pl

Annette HAILES
 b
 pl 24/5/94 in UK
 Cecil GODFREY
 b
 pl

Charles GODFREY
 b
 pl
 Guy GODFREY
 b
 pl
 Jennifer GODFREY
 b
 pl

Peter HAILES
 b
 pl Hapuka, Kaikoura 1992
 Noeline EDWARDS
 b
 pl Hapuka Kaikoura 1992
 21/5/94 at 5

Lynn HAILES
 b
 pl Bienhiem 1992
 MARK HAILES mtd Carol GREEN P5-11
 b
 pl Tasmania Aust. 1992
 Bernard HAILES mtd Rosalie LeCREN P5-11
 b
 pl
 Anna HAILES
 b
 pl

Geoffrey HAILES
 b
 pl

Jenny HAILES
 b
 pl Wellington 1992
 Keith GERARD
 b
 pl WELLINGTON ← Jan 94

Mary HAILES
 b
 pl
 Brian HASSELL
 b
 pl

Geoffrey HASSELL
 b
 pl
 Jane HASSELL
 b
 pl
 Stephen HASSELL
 B
 PL
 Lynette HASSELL
 b
 pl

Margaret HAILES
 b
 pl
 Kevin BRAUN
 b
 pl

Robert BRAUN
 b
 pl
 Kathryn BRAUN
 b
 pl

7th Generation

8th Generation

[5-11] Mark HAILES
 b
 pl
 Carol GREEN
 b
 pl

Erma HAILES
 b
 pl
 Kate HAILES
 b
 pl

[5-11] Bernard HAILES
 b
 pl
 Rosalie LeCREN
 b
 pl

Milissa HAILES
 b
 pl
 David HAILES
 b
 pl

5th Generation

6th Generation

7th Generation

[5-1]Norma Agnes Mary HAILES
b 16 Oct 1901 @ Kaikoura
d @ Papakura
Leo HODGSON
b
d

Mary HODGSON
b
pl
Doug M'LEOD
b
pl

Beverly M'LEOD
b
pl
Briam M'LEOD
b
pl

[5-1]Ronald Joseph HAILES
b 17 May 1903 @ Kaikoura
d 9 Sept 1960 age 56 Whangarei
Olive Mary PATRICK
b 15 Nov 1914 @ Melbourne
d 23 Sept 1983 @ Whangarei

Richard (Dick) Patrick HAILES
b 1 March 1932
pl Whangarei

Jill Mary HAILES
b 25 Feb 1934
pl Surfiers Paradise Australia
(1)Neville Lance LINWOOD @ Whangarei
b 8 Aug 1930 @ Kaikohe
pl
(2)Graham CAPPERKY 27 May 1980 @ Brisbane
b
d 12 April 1992

(1)Kevin LINWOOD
b 8 May 1953 @ Te Awamutu
pl Queensland 1992
(1)Raymond LINWOOD
b 23 March 1957 @ Whangarei
pl Queensland 1992
(1)Mark LINWOOD
b 1 Dec 1960 @ Whangarei
pl Queensland 1992

Marie Olive HAILES
b 5 Oct 1937
pl Whangarei 1992
David MacLeod COOK 31 Aug 1963
b 11 April 1931 @ Petone
d 10 Sept 1991

Casey Maryanne COOK
b 8 Jan 1965
pl London UK 1992
Annermarie Olive COOK
b 17 Feb 1966
pl Whangarei 1992
Philip Joseph COOK
b 27 Aug 1968
pl Christchurch
Martin David COOK
b 16 Aug 1969
pl Canberra Australia 1992

d 28 April 95 @ Cave Creek

Ronald (Mike) Michael HAILES
b 3 Aug 1953 @ Whangarei
pl Auckland 1992
Barbara NIDDRIE
b 31 Dec 1954 @ Auckland
pl

Olivia Mary HAILES
b 30 March 1980 @ Whangarei
pl
Ronald Michael HAILES
b 23 Oct 1981 @ Rotorua
pl

[5-1]Bernard Joseph HAILES
b 17 April 1908 @ Kaikoura
d 12 Feb 1980 @ Southport Queensland
Nellie SLAKO
b 31 May 1908 @ Pawaerengarenga
pl Queensland

Colleen Margaret HAILES
b 7 November 1932 @ Whangarei
pl Perth
Doug HOLMES @ Auckland 1950
b 15 May 1928
pl Perth 1992

John Douglas HOLMES md (1)Jewell BOARD (2)Amanda SLOMP
b 28 Jan 1952 @ Sydney
pl Perth 1992
David Bernard HOLMES (1)Rose ROCKICH (2)Clare GRAINGER
b 24 Nov 1954 @ Auckland (3)Anchelle KHONGATHAPPHA
pl Perth 1992

P5-13

p5-13

Leon Bernard HAILES
b 12 June 1934
pl Queensland 1992
Coral SERGENT @ Auckland
b
pl Queensland 1992

Cindy HAILES
b
d
Mark HAILES
b
pl
Sherce HAILES md Mark WILLIAMS
b
pl
Jason HAILES
b
pl

Barry Milan HAILES
b 12 May 1942 @ Whangarei
pl Brisbane 1992
Gabrielle FANNING St Columbans Frankton Ham. 16-11-1968
b 8 Nov 1942
pl Brisbane

Mary Louise HAILES
b 27 August 1969 @ Auckland
pl Christchurch 1992
Catherine Ann HAILES
b 31 Nov 1970 @ Auckland
pl London 1992
Milan Bernard Robert HAILES
b 30 June 1972
pl Brisbane
Mathew Barry HAILES
b 31 July 1977 @ Auckland
pl Brisbane 1992

[5-1]Mary Elizabeth (Betty) HAILES
b 16 Nov 1912
d @ Christchurch
Ted GULLIVER
b
d

Patricia GULLIVER
b
pl
Ray BEAVEN
b
pl

*md Ray
Bruce Brown
Scott Brown
Trudy Brown*

[5-1]Joseph Walter HAILES
b 10 Dec 1913
26 Mar 1978 @ Papakura
Nell O'BRIEN
b
pl Papakura

Therese HAILES
b 21/2/48
pl *Art Reskill*
Margaret HAILES
b 21.6.1950
pl *Penselburg*
Michael HAILES
b 21/3/52
pl *Perth*
Pauline HAILES
b 20/1/56
pl

*md Owen Mulligan
- Joanne
- Bernadette
md Ross Nicholson
- Anthony
- Bea Kenneth
- Bruce
md Gordon Kellow
- N/C
md Ray Fitness
- Natalie
- Clinton*

7th Generation

8th Generation

{5-12} John Douglas HAILES
b 28 Jan 1952
pl Perth 1992
(1) Jewell BOARD @ Avondale
b
pl
(2) Amanda SLOMP
b
pl

(1) Gayne HOLMES
b 31 Aug 1975
pl
(1) Travers HOLMES
b 6 Nov 1977
pl
(1) Gareth HOLMES
b 24 July 1979
pl

{5-12} David Bernard HOLMES
b 24 Nov 1954
pl Perth 1992
(1) Rose Rockich 11-11-1977 Camarven, Perth
b
pl
(2) Clare GRAINGER
b
pl
(3) Anchelle KHONGATHAPPHA
b
pl Perth 1992

(1) Steven HOLMES
b 11 Jan 1976
pl
(3) Geoffrey HOLMES
b 23 June 1988
pl
(3) Vanessa HOLMES
b 13 Jan 1992
pl

5th Generation

6th Generation

7th Generation

[5-1]Walter Edward HAILES
b 16 June 1916
d
Adele HARRIS
b 27 Nov 1919
pl

Terence HAILES
b 5 Aug 1940
pl
Margaret HODGSON (nee LYNCH)
b
pl

Daniel HAILES
b 18 May 1942
pl Whangarei
Lorraine KEYES
b
pl

Lance HAILES md Lynette BOWLING
b 8 Feb 1969
pl Whangarei 1992

P5-14

Jennifer HAILES
b 23 March 1972
pl

Craig HAILES
b 7 April 1976
pl

Raymond HAILES
b 10 May 1944
pl Maungatapere
Raewyn THOMSON
b
pl

Jackie HAILES md Trevor CURREN
b 10 Dec 1964
pl

P5-14

Grant HAILES
b 2 Oct 1967
pl

Michelle HAILES
b 4 July 1970 twin with Denise
pl

Denise HAILES
b 7 July 1970 twin with Michelle
pl

Louise HAILES
b 15 March 1957
pl Whangarei
David ALDERTON
b
pl

7th Generation

8th Generation

[5-14]Lance HAILES
b 8 Feb 1969
pl
Lynette BOWLING
b
pl

Taylor-Rae HAILES
b 4 Nov 1991
pl

[5-14]Jackie HAILES
b 10 Dec 1964
pl
Trevor CURREN
b
pl

Emma CURREN
b 16 Aug 1988
pl

Ryan CURREN
b 27 Nov 1989
pl

Aimee CURREN
b 4 July 1992
pl

SECTION 6

GEORGE JAMES HAILES & LUCY JULIANA PENDRELL

Lucy died on 9 July 1861 after bearing eleven children, only 3 of these survived, which possibly is part of the reason George packed up and came to New Zealand with his brother Walter Mary and niece Helen Giles, presumably to assist in looking after the children. Also on board were some Ward relations.

Lucy was buried at Saint Mary's Church, Brewood, very close to where they lived at "Strangleford Birch". Kiddemore Green, Staffordshire, England. According to letters, in 1848 Lucy lived at Stafford Road, Wolverhampton. The Pendrell's were a devout Roman Catholic family, Lucy's sister became Prioress of Saint Joseph's Carmelite Order, Valognes, France in 1846 and was still there in 1860 when she last wrote to Lucy.

The Pendrell's were descended from the Pendrell family who sheltered and led part way to safety, Charles II after he was defeated at the Battle of Worcester in 1651. George and John Pendrell lived at "White Ladies", a manor house built in the half timbered style erected besides the ruins of a monastery. It was built in the form of a quadrangle, and enclosed by

a wall in which an old gabled gate house was set. The Pendrell's were retainers of the Giffard family, a landed catholic family who owned Chillington Hall and supported Charles II. Persecuted priests often used their house for hiding. Francis Yates was married to Elizabeth Pendrell and he led Charles to "White Ladies". Charles hoped to cross the boarder into Wales at Madeley and was led by Richard Pendrell to his home, "Hobbal Grange" where he cut his hair and dressed him in yokel clothes, belonging to his brother, Humphrey. Humphrey, a miller, being as tall as the King. Richard's mother was living at "Hobbal Grange" with Richard, his wife, and Nan their daughter. After travelling nine miles to Madeley with Richard it was found that escape across the boarder was impossible with all bridges and fords well policed by Cromwell's men. So Charles was led back to Boscobel House, only one mile from "White Ladies", home of William and Joan Pendrell. Boscobel House was a Hunting Lodge belonging to the Giffard's and had two hiding places, one behind a wall panel that led down a secret stairway in the chimney straight into the forest, and one a "priests hole" under the floor of the cheese store at the top of the house. Charles spent some time in each place plus the legendary Oak tree with Cromwell's soldiers searching the woods under him at one time. He was eventually led by John Pendrell to Mosely Hall near Wolverhampton, the home of Whitgreave, also a sympathetic to the Catholic cause.

When Charles was restored to the throne in 1660 he granted the Pendrell's an Annuity "forever". William and Richard each received £100, Humphrey, John and George received 100 marks and Elizabeth Yates, daughter of old William Pendrell, received £50. Her husband had been killed by Cromwell. Richard Pendrell died 8 February 1672 leaving four sons and four daughters. He was buried at Saint Giles in the field and his tomb was restored and beautified by George II in 1739.

George Hailes sailed to New Zealand with his three surviving children, Lucy, Agnes and George, arriving in Nelson 2 October 1862 on the "Edward Thornhill". They settled in Upper Takaka and called their property "Waitui Park". Descendants of his son, George and Mary Leonard, still farm the area.

Researched by Ngaere Hailes

3rd Generation

4th Generation

5th Generation

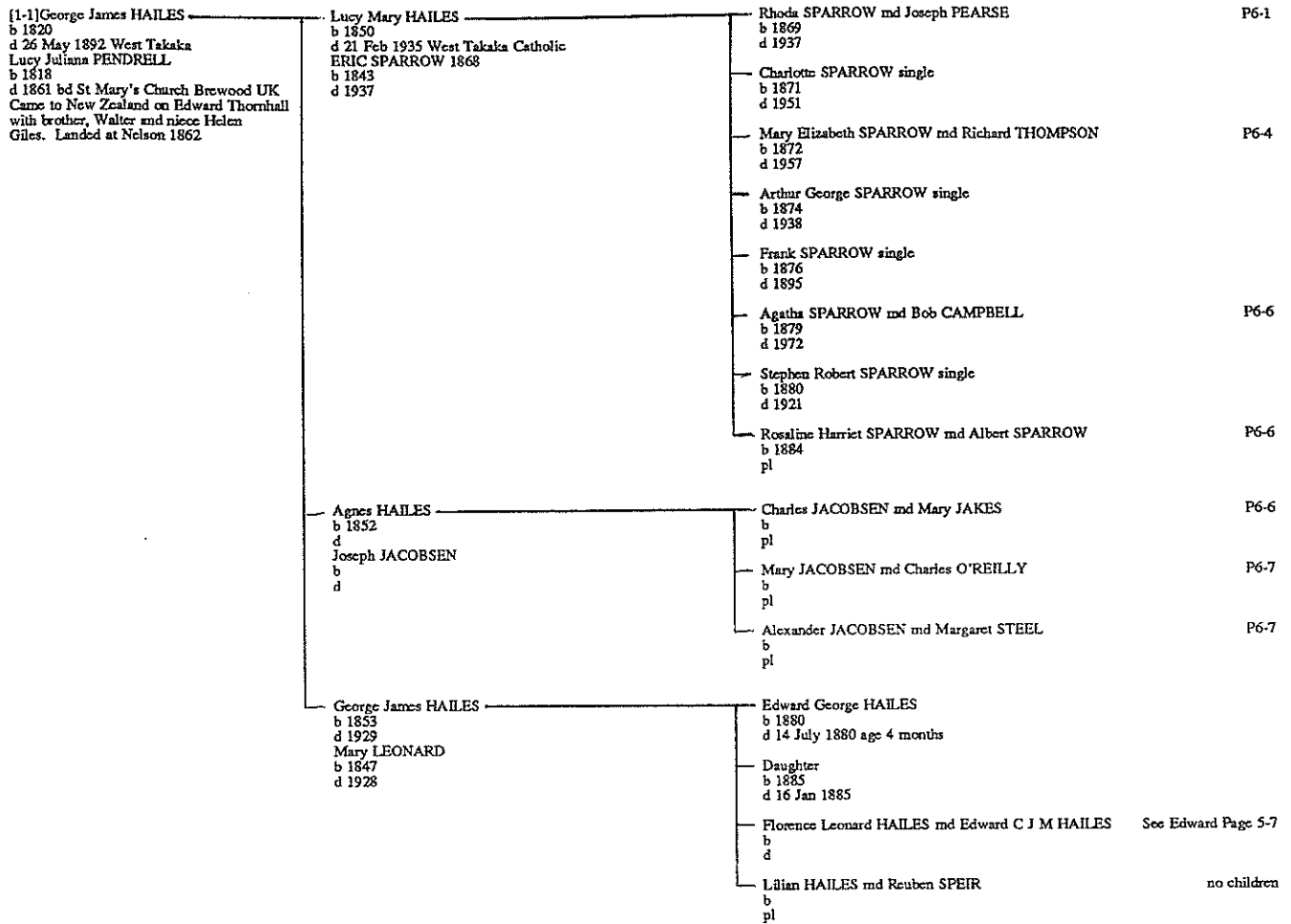

5th Generation

6th Generation

7th Generation

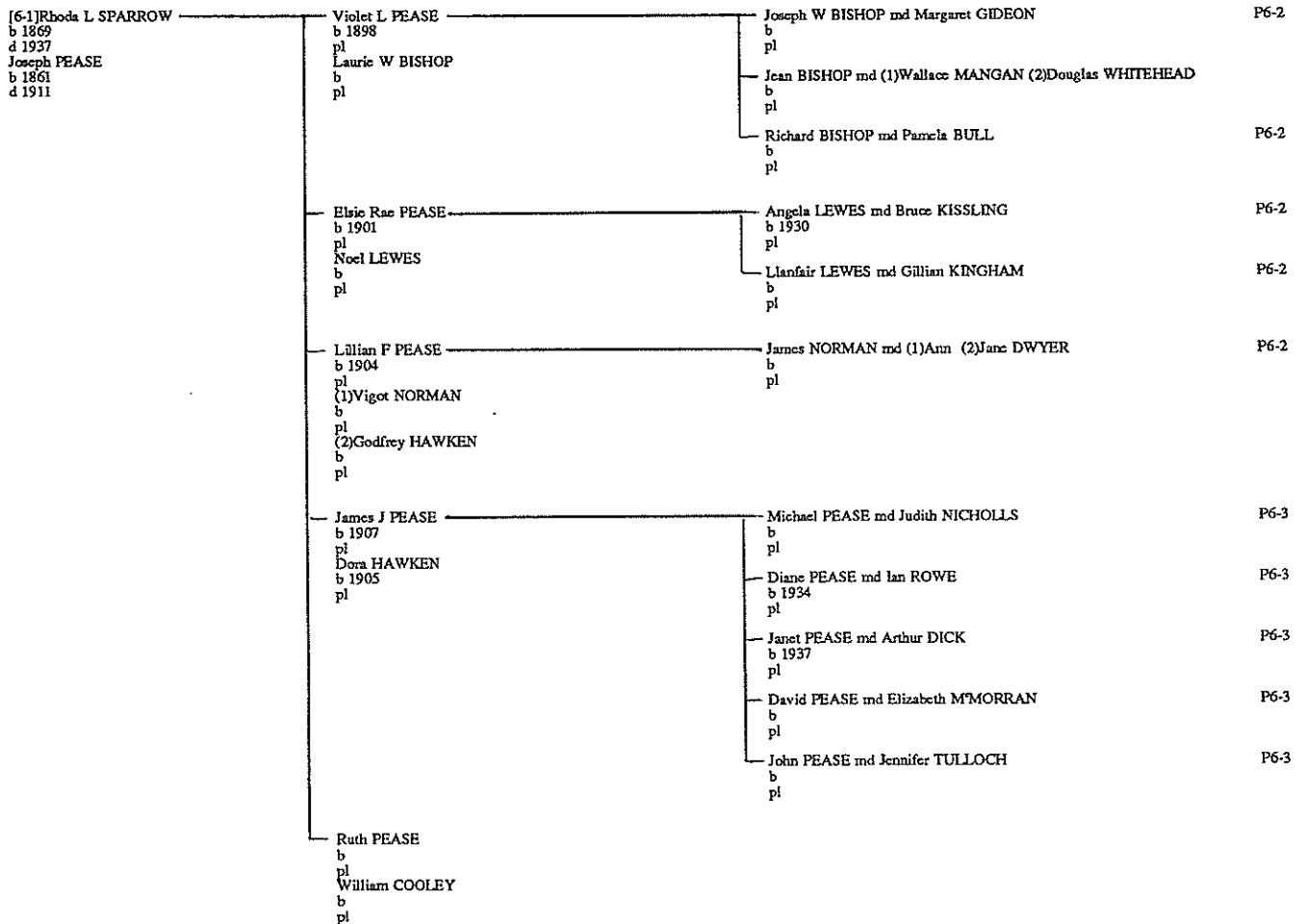

7th Generation

8th Generation

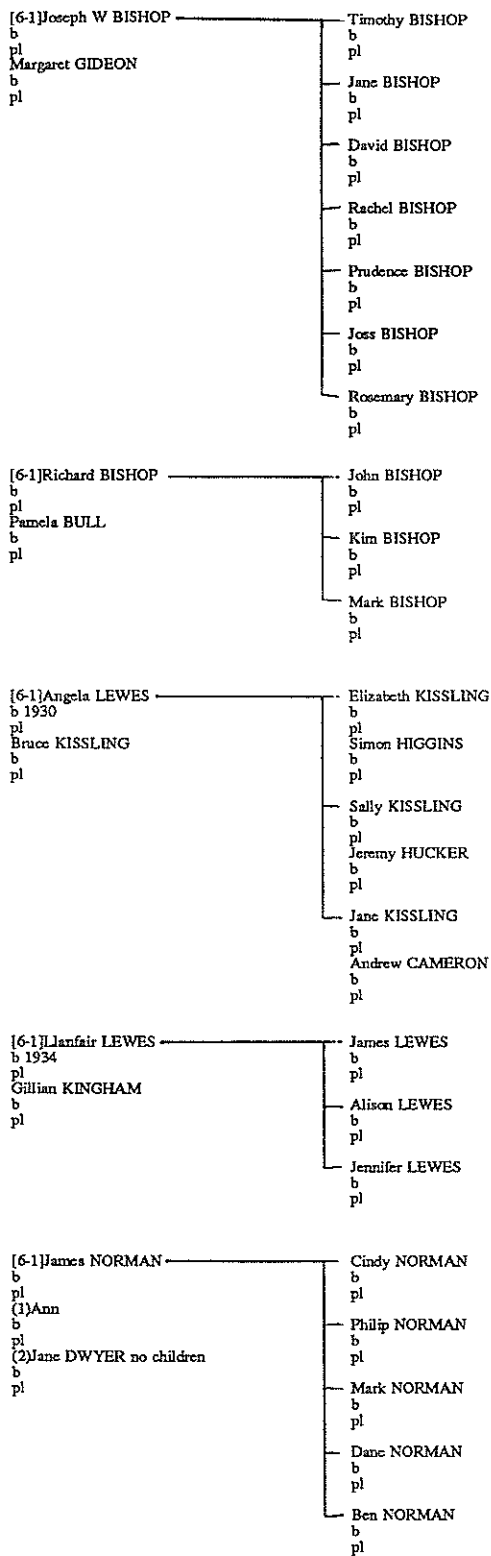

7th Generation

8th Generation

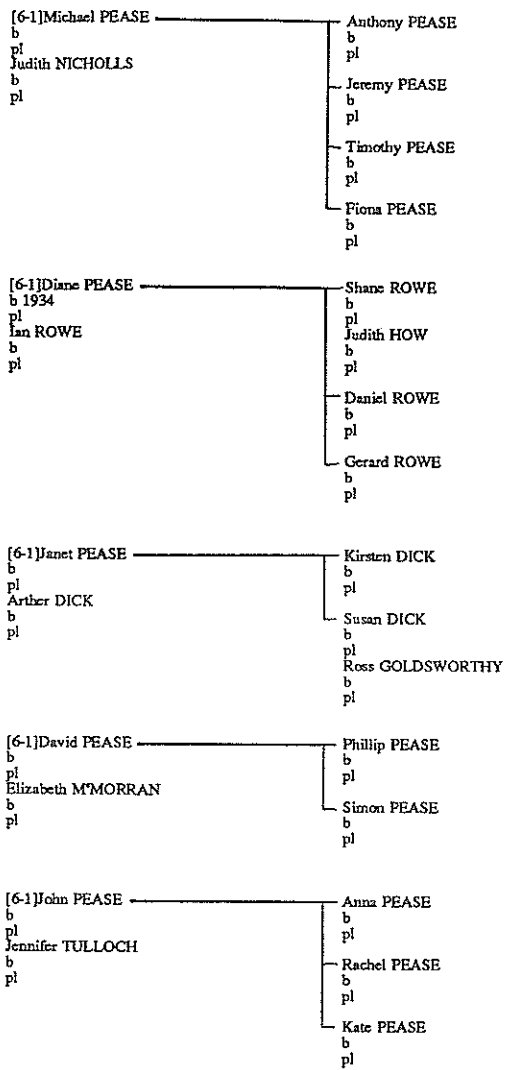

5th Generation

6th Generation

7th Generation

[6-1] Mary Elizabeth SPARROW
b 1872
d 1957
Richard THOMPSON 1901
b 1847
d 1931

George Eric THOMPSON
b 1902
d 1976
Mavis DEATH 1929
b 1905
pl

John W THOMPSON
b 1905
d 1986
Edna A DEATH 1933
b 1907
pl

Elizabeth THOMPSON md Trevor WHEELER
b 1930
pl

Richard THOMPSON md (1) Mary HARRISON (2) Ann STEWART
b 1932
pl

Pamela THOMPSON md Barry BENHAM
b 1934
pl

Joan THOMPSON md Peter M'LEAN
b twin with Jennifer
pl

Jennifer THOMPSON md Neil JARMAN
b twin with Joan
pl

George THOMPSON md Wendy SMITH
b 1945
pl

Margaret Alison THOMPSON md Colin SMITH
b 1936
pl

Roger W THOMPSON md Dawn DAVIDSON
b 1939
pl

Claire THOMPSON md Ross A CORRIGAN
b 1942
pl

Janet THOMPSON md Noel REED
b 1952
pl

P6-5

P6-5

P6-5

P6-5

P6-5

P6-5

P6-5

no children

P6-5

P6-5

7th Generation

8th Generation

9th Generation

[6-4]Elizabeth THOMPSON
b 1930
pl
Trevor WHEELER
b
pl

Warren WHEELER
b 1954
pl
Malcolm WHEELER
b
pl
Colin WHEELER
b
pl
Jacqui DEETH
b
pl
Linda WHEELER
b
pl

[6-4]Richard THOMPSON
b 1932
pl
(1)Mary HARRISON
b
pl
(2)Ann STEWART no children
b
pl

Andrea THOMPSON
b
pl
Nick O'NEIL
b
pl
Peter THOMPSON
b
pl

Ben O'NEIL
b
pl

[6-4]Pamela THOMPSON
b
pl
Barry BENHAM
b
pl

Lyndsey BENHAM
b
pl
Gerald BENHAM
b
pl
Justin BENHAM
b
pl

[6-4]Joan THOMPSON
b twin with Jennifer
pl
Peter M'LEAN
b
pl

Bruce M'LEAN
b
pl
Lesley M'LEAN
b
pl
Tom M'LINDON
b
pl
Murray M'LEAN
b
pl

[6-4]Jennifer THOMPSON
b twin with Joan
pl
Neil JARMAN
b
pl

Gregory JARMAN
b
pl
Derek JARMAN
b
pl

[6-4]George THOMPSON
b 1945
pl
Wendy SMITH
b
pl

Ross THOMPSON
b
pl
David THOMPSON
b
pl
Kylie THOMPSON
b
pl

[6-4]Margaret Alison THOMPSON
b 1936
pl
Colin SMITH
b
pl

Stephen SMITH
b 1960
pl
Liane SMITH
b 1962
pl
Craig SHORT
b 1959
pl
Melinda J SMITH
b 1967
pl
Phillippa T SMITH
b 1969
pl

Jason SHORT
b 1968
pl

[6-4]Claire THOMPSON
b 1942
pl
Ross A CORRIGAN 1964
b 1936
pl

Andrew CORRIGAN
b 1965
pl
Duncan CORRIGAN
b
pl
Fiona CARTER
b
pl
Kirsten CORRIGAN
b 1970
pl

[6-4]Janet THOMPSON
b 1952
pl
Noel REED
b
pl

Christopher REED
b 1985
pl
Lucinda REED
b 1987
pl

5th Generation

6th Generation

7th Generation

[6-1]Agatha SPARROW
b 1879
d 1972
Bob CAMPBELL
b
pl

Bruce CAMPBELL
b
pl
Gladys EYLES
b
pl

Nicki CAMPBELL
b
pl
Nan CAMPBELL
b
pl
Naomi CAMPBELL
b
pl

Elizabeth CAMPBELL
b
pl
Dane MACKY
b
pl

Joseph MACKY md Barbara ROGERS
b
pl
Bob MACKY md Jane Elizabeth COLE
b
pl
Bill MACKY md Sue WHEELER
b
pl
Kim MACKY
b
pl

P6-6

P6-6

[6-1]Rosaline Harriet SPARROW
b 1884
d 1983
Albert SPARROW
b
pl

Frank SPARROW
b
pl
Irene
b
pl

Stephen SPARROW
b
pl

7th Generation

8th Generation

[6-6]Joseph MACKY
b
pl
Barbara ROGERS
b
pl

Oliver MACKY
b
pl
Edward MACKY
b
pl

[6-6]Bob MACKY
b
pl
Jane Elizabeth COLE
b
pl

Anna MACKY
b
pl
Claire Margaret MACKY
b
pl
Julia MACKY
b
pl

5th Generation

6th Generation

[6-1]Charles JACOBSEN
b
pl
Mary JAKES
b
pl

Charles JACOBSEN
b
pl
Mary ASTON
b
pl
Myrtle JACOBSEN
b
pl
M FIRETH
b
pl
Molly JACOBSEN
b
pl
DUNN
b
pl
Noeline JACOBSEN
b
pl
HANCASTLE
b
pl
Phyllis JACOBSEN
b
pl
IVANY
b
pl
Jean JACOBSEN
b
pl
RUTHERFORD
b
pl
Gilla JACOBSEN
b
pl
BARRY
b
pl
Eric JACOBSEN
b
pl
Amy LANE
b
pl
David JACOBSEN
b
pl

5th Generation

6th Generation

7th Generation

[6-1] Mary JACOBSEN
b
pl
Charles O'REILLY
b
pl

Marcella O'REILLY
b
pl
Allan HART
b
pl

Graham HART
b
pl
Margaret HART
b
pl

Mary O'REILLY
b
pl
Jack MORAN
b
pl

John MORAN
b
pl
Ruth MORAN
b
pl
Hugh MORAN
b
pl

Catherine O'REILLY
b
pl
Peter PARSONS
b
pl

Michael PARSONS
b
pl
Bernard PARSONS
b
pl
Patricia PARSONS
b
pl
Maurcen PARSONS
b
pl

Kevin O'REILLY
b
pl

Margaret O'REILLY
b
pl
Roy O'BRIEN
b
pl

Neil O'BRIEN
b
pl
Karen O'BRIEN
b
pl
Colleen O'BRIEN
b
pl

[6-1] Alexander JACOBSEN
b
pl
Margaret STEEL
b
pl

Zilla JACOBSEN
b
pl
Gordon RUTHERFORD-BELL
b
pl

Terence RUTHERFORD-BELL
b
pl
John RUTHERFORD-BELL
b
pl

Madge JACOBSEN
b
pl
L
b
pl

Alex JACOBSEN
b
pl
Lorna
b
pl

Edward JACOBSEN
b
pl
Ruth
b
pl

SECTION 7

ELIZABETH HAILES
&
JOHN ALBOT

3rd Generation

[1-1] Elizabeth HAILES
b 2 Feb 1826
d 2 April 1863
George John ALBOT 3 May 1848
b
d

4th Generation

Barbara Mary ALBOT
b 4 March 1849
d
Thomas HOWELE of Middleton York 2 July 1877
b
d

Mary Theresa ALBOT
b 14 March 1857
d 28 April 1858

5th Generation

SECTION 8

INDEX

INDEX

Be aware that the same name can appear more than once on the same page for the same reference. The date in brackets is the birth date where available.

ALBOT	Barbara Mary (1849)	7-1	BLACK	Timothy	6-2	CODY	Patricia	5-9
	Elizabeth	1-1, 4-1		Donna	2-6	COLE	Jane Elizabeth	6-6
	George John	1-1, 7-1		Glen	2-6	COLLINS	Edith (1885)	2-1, 2-14
	Mary Theresa (1857)	7-1		Kathy	2-5, 2-6	COMERFORD	Terence	4-2
ALDERTON	David	5-14	BOARD	Warwick	2-6	COOK	Annemarie Olive (1966)	5-12
ALDRIDGE	Sally	2-14		Jewell	5-12, 5-13		Casey Maryanne (1965)	5-12
ALLAN	Charlotte	2-4	BOLTON	Poly	5-1		David MacLeod (1931)	5-12
	Ross	2-2, 2-4	BOWIE	Claire	4-3		Martin David (1969)	5-12
ANTHONY	Craig	2-16		Kathleen	4-3	COOLEY	Philip Joseph (1968)	5-12
	Joshua	2-16	BOWLING	Keith Leslie	4-2, 4-3		William	6-1
	Winifred	2-15, 2-16	BOWYER	Lynette	5-14	CORBELL	Andrew	2-6
ARCHER	Kathleen Patricia	5-11		Heather	2-11		Gavin	2-6
ARMSTRONG	Catherine	5-5, 5-6		Henry (Harry)	2-11		Joanne	2-6
ARNELL	Ethel	2-15		Jenny	2-11		Keith	2-6
ASTON	Mary	6-6		Peter	2-11		Steven	2-6
ATTWOOD	Beverley	2-11		Tessa	2-11	CORRIGAN	Andrew (1965)	6-5
AUSTIN	Barbara	2-6	BOYLON	Timothy	2-11		Duncan	6-5
BALDWYN	Lucy (1781)	1-1		Alex	2-16		Kirsten (1970)	6-5
BARBER	David	2-17		Cory	2-16		Ross A (1936)	6-4, 6-5
BARKWITH	Antony	2-11		Duanne	2-16	COUGHLAN	Elizabeth	5-1, 5-9
	Beryl	2-11	BRAUN	Shadae	2-16	COURNANE	Donna	5-9, 5-10
	Catherine	2-11		Kathryn	5-11	CROW	Deanne	2-17
	Colin	2-11		Kevin	5-11		Donna	2-17
	Craig	2-11	BRENNAN	Robert	5-11		Jan-Maree	2-17
	James	2-11		Ngaere (1928)	5-7		Robert	2-15, 2-17
	Janet	2-11	BRISTOW	Emma	2-7		Toni	2-17
	June	2-11, 2-12		Kate	2-7	CURREN	Aimee (1992)	5-14
	Lynne	2-11		Russell	2-6, 2-7		Emma	5-14
BARNETT	Jacqueline	2-6, 2-7	BROCKLEBANK	Cara Jane	2-4	DAVIDSON	Ryan (1989)	5-14
BARTNICZAK	Theo	2-2		Graham	2-4		Dawn	6-4
BAUER BORGEHN	M. Baron von	4-1	BROWN	Agnes Norma (1874)	5-1	DAVIS	Antony Colin	4-2, 4-3
BEAMISH	Charles	2-2, 2-3	BRYANT	Dilys	5-5		Jane Patricia	4-3
	Jennifer	2-3	BUCHANAN	Valda	2-5, 2-10		Kathryn Louise	4-3
	Kevin	2-3	BULL	Bryan	2-11		Mark	4-3
BEAVEN	Ray	5-12		Pamela	6-1, 6-2	DAWSON	Margaret	2-11
BENHAM	Barry	6-4, 6-5	BURGESS	Judith	2-17	DAY	Christopher	4-2
	Gerald	6-5		Leon	2-17		Geraldine	4-2
	Justin	6-5		Ross	2-17		James	4-2
	Lyndsey	6-5		Sharon	2-17		Mary	4-2
BENNETT	David	2-3	BURKE	William	2-15, 2-17	DEATH	Edna A (1907)	6-4
	Grant	2-3		Bridgette	5-3		Mavis (1905)	6-4
	Karen	2-3		Imelda	5-3	DEETH	Jacqui	6-5
	Terry	2-3		Michael	5-2, 5-3	DENT	Graham	2-8
BICKERS	Angela Mary (1979)	5-6	BYRNE	Siobhan	5-3		Hayden	2-8
	Graham	5-5, 5-6		Mary	2-2, 2-4	DESHA	Paul	2-8
	Mathew (1973)	5-6	CAFFERKY	Graham	5-12		Miriam	2-6
	Nathan (1975)	5-6	CAMERON	Andrew	6-2		Nina Helen	2-6
BIELSKI	Anna	2-18	CAMPBELL	Bob	6-1, 6-6		William	2-5, 2-6
	Dean	2-18		Bruce	6-6	DEVERAUX	Evelyn	2-10
	Jeannette	2-18		Elizabeth	6-6		Kelly	2-10
	Victor	2-15, 2-18		Michael	5-2		Peter	2-10
BIRD	Bernard	2-2, 2-3		Nan	6-6	DICK	Arthur	6-1, 6-3
	Ian	2-3		Naomi	6-6		Kirsten	6-3
	Mark	2-3		Nikki	6-6		Susan	6-3
	Neil	2-3		William Arthur	3-1	DOGGETT	Charles	2-2
	Patricia	2-3	CARR	Christine	2-9		Charmaine	2-3
BISHOP	David	6-2		Amy Maria (1861)	3-1		David	2-3
	Jane	6-2		Fiona	6-5		Doreen	2-2
	Jean	6-1	CAVNESS	Steven	2-16		John	2-2, 2-3
	John	6-2		Tyson	2-16		Julien	2-2, 2-3
	Joseph W	6-1, 6-2	CHAPMAN	Denise	2-14		Karine	2-3
	Joss	6-2		John	2-5		Luke	2-3
	Kim	6-2		Nola	2-5, 2-9		Mary (Mol)	2-2, 2-3
	Laurie W	6-1	CHATTERTON	David	2-3		Ngairie	2-2, 2-3
	Mark	6-2	CHEESEMAN	Clementine	4-1, 4-2		Robyn	2-3
	Prudence	6-2		Prof. John	4-2		Shirley	2-3
	Rachel	6-2	CLARK	Rod	2-13	DONALDSON	Gail	2-9
	Richard	6-1, 6-2		Bernice	2-15, 2-16	DRAGER	Angela	2-13
	Rosemary	6-2	CLELAND	Nora	5-1		Ann	2-12
	Sharon	3-1		Cheese	4-2		Barry	2-11, 2-12
				Bertha Ellen (1883)	2-1		Brian	2-14
				Carole Foote	2-14		Carole Foote	2-14
				Charles	2-13		Charles	2-13
				Charles Louis	2-11		Charles Louis	2-11
				Christina Lilian	2-11		Christina Lilian	2-11

Christine	2-12	Margaret	5-8	Barbara Winifred (1828)	1-1
Christopher Louis (1870)	2-1, 2-11	Michael	5-8	Barry Milan	5-12
Corinne	2-11, 2-12	Sister Frances	5-8	Bernard	5-1, 5-11
Damian Louis	2-13	William	5-8	Bernard Joseph (1908)	5-1, 5-12
Fritz A (1878)	2-1, 2-14	GALBRAITH		Brian	5-2, 5-3
Geraldine	2-13	Emilia (Elsie)	2-5	Carina	5-2, 5-3
Harold	2-11	Florence	2-5	Cassie	5-3
Haydn	2-13	Helen	2-5	Catherine (1961)	5-7
Herbert Louis (1867)	2-1	Hubert Louis	2-5	Catherine Ann	5-12
Ian	2-14	Ian	2-5, 2-9	Christine	5-4
Janis	2-11, 2-12	James Angus	2-5	Christopher	5-9
Joanne	2-12	Jeanette	2-5, 2-9	Cindy	5-12
Karen	2-14	Joanne	2-10	Clint (1977)	5-6
Lennette	2-13	Joyce	2-5	Colleen	5-12
Leona	2-14	Katrina	2-9	Conrad (1974)	5-2
Leonard	2-13	Leon	2-5	Cornelius (Con) Joseph	5-1, 5-9
Leonard S (1875)	2-1, 2-13	Lila	2-5	Craig (1976)	5-14
Lewis	2-11, 2-12	Louis William	2-5	Daniel	5-14
Louis	2-1	Lucy Ann	2-5	Daniel (Danny) (1966)	5-2, 5-3
Louis (Ted)	2-14	Maxwell	2-5, 2-6	David	5-2, 5-4, 5-11
Louis W	2-13	Nina Janet	2-5	Deborah	5-4
Lucy Ann (1868)	2-1	Noel	2-5, 2-10	Denise (1970)	5-14
Lucy Ann 1868	2-5	Robert	2-5	Dominic	5-3
Lynsey	2-14	Sean	2-9	Dylon	5-3
Margaret	2-13	William	2-1	Edward	4-1, 5-1, 5-9
Marie	2-14	William 1855	2-5	Edward (1782)	1-1
Mark	2-14	Winifred	2-5	Edward (1812)	1-1
Michael	2-12	GALLOWAY		Edward (1813)	1-1, 4-1
Murray	2-14	Andrew	2-12	Edward C J M (1891)	5-1, 5-7, 6-1
Neta	2-14	Garth	2-11, 2-12	Edward George (1880)	6-1
Ngairé	2-11, 2-12	James	2-12	Eileen	5-2, 5-3
Nigel	2-12	GARNHAM		Elizabeth	4-1
Otto Giles (1873)	2-1, 2-13	Jackie	2-15, 2-18	Elizabeth (1826)	1-1, 7-1
Robert	2-14	GARRETT		Ellen Mary (Mary) (1906)	5-1, 5-5
Sharron	2-12	Ethel	5-8	Emma	5-11
Trevor	2-12	GÉDDIS		Erin (1960)	5-7
Valerie	2-13	George	2-5, 2-8	Felix	5-1
Wilhemina Mary (1865)	2-1, 2-2	GERARD		Felix Joseph	5-1, 5-11
William	2-11, 2-12, 2-13	Keith	5-11	Florence Leonard (Floss) (1891)	5-1, 5-7, 6-1
Winifred Rose (1880)	2-1, 2-15	GIBSON		Frances	5-1, 5-8
DRAPER		Alison	2-8	Frances 1805	1-1
Caroline (1981)	5-6	Bradley	2-8	Frances Mary (1811)	1-1
Catherine Carol (1957)	5-5, 5-6	Desmond	2-8	Francis	5-4
Demelza (1982)	5-6	Maurice	2-5, 2-8	Francis (Frank) John Nathouiel	
Graham Walter (1950)	5-5	Michael	2-8	(1926)	5-2
Jessica (1989)	5-6	Michelle	2-8	Frank	5-4
John Craig Thomas (1960)	5-5	Natalie	2-8	Frank John (1904)	5-1
Joshua (1984)	5-6	Peter	2-8	Gabrielle (1964)	5-7
Katie (1983)	5-6	Ryan	2-8	Geoffrey	5-11
Laura (1991)	5-6	Yolande	2-8	George	4-1
Linda (1989)	5-6	GIDEON		George (1924)	5-7
Lorraine Noeline (1951)	5-5, 5-6	Margaret	6-1, 6-2	George James (1820)	1-1, 6-1
Mark Patrick (1958)	5-5, 5-6	GILES		George James (1853)	6-1
Paula Mary (1969)	5-5, 5-6	A	4-1	George Philip (1945)	5-2
Rachael Ellen	5-6	Helen	5-1	Gerard	5-11
Robert Clive (1955)	5-5, 5-6	Helen (1841)	2-1	Graham Walter (1960)	5-6
Walter W	5-5	John	1-1, 2-1	Grant (1967)	5-14
DUNCAN		GITMANS		Helen (1812)	1-1, 3-1
James	5-11	Jason	2-8	Holly (1984)	5-6
DUNN		Lisa	2-8	Ian	5-2, 5-3
Unknown	6-6	Michael	2-8	Imelda Jane (1977)	5-2
DUNNE		Paul	2-8	Jackie (1964)	5-14
Bella	5-1	GODFREY		James	1-1, 5-11
DWYER		Cecil	5-11	James (1778)	1-1
Jane	6-1, 6-2	Charles	5-11	James (1807)	1-1
Mary Francis	5-1	Guy	5-11	James (1831)	1-1
EAST		Jennifer	5-11	Jason	5-12
Lillian	4-1, 4-2	GOLDSWORTHY		Jennifer (1972)	5-14
EBBETT		Ross	6-3	Jenny	5-11
Raewyn	2-3	GOODMAN		Jill Mary (1934)	5-12
EDMONDS		Helen	5-8	John	5-4, 5-11
Regine	2-11	GOODRICK		John Douglas	5-13
EDWARDS		Judy	5-5, 5-6	John-Leslie	5-9
Noeline	5-11	GOODWIN		Joseph (1785)	1-1
ELLIOT		Adele	2-8	Joseph M	5-1
Myrtle	2-5, 2-6	Ian	2-8	Joseph Walter (1913)	5-1, 5-12
William	2-5	GRAINGER		Josephine	5-7
EYLES		Clare	5-13	Julia	5-4
Gladys	6-6	GRANT		Karen	5-10
FAIRHURST		A	4-1, 4-2	Kate	5-11
Shay	2-16	GREEN		Kathlyn	5-3
Tara	2-16	Carol	5-11	Kevin	5-9
Wayne	2-16	Jenny	2-8	Kieran	5-3
FANNING		GRINDROD		Lance (1969)	5-14
Gabrielle	5-12	Kate	2-12	Lauren	5-3
FIRETH		Ryan	2-12	Leon Bernard	5-12
M	6-6	William	2-12	Leslie	5-9
FLANNAGAN		GULLIVER		Lillian	6-1
Marie	2-11, 2-12	Patricia	5-12	Louise	5-2, 5-14
FLYNN		Ted	5-1, 5-12	Luke (1981)	5-6
Anita	5-9	GUYMER		Lynn	5-11
FOGARTY		Florence	2-5	Maggie	5-1, 5-8
Edel	5-2, 5-3	HAILES		Margaret	5-7, 5-11, 5-12
FRANCES		Agnes (1823)	1-1	Mane Olive (1937)	5-12
Ann	1-1	Agnes (1852)	6-1	Marita	5-9
FRANKLIN		Agnus (1842)	4-1	Mark	5-11, 5-12
Marilyn	2-8	Angela	5-9	Mark (1958)	5-7
FULLER		Anita	5-2, 5-3	Mary	4-1, 5-1, 5-2, 5-3, 5-7, 5-11
Nada	2-13	Ann (1775)	1-1	Mary (1965)	5-7
GAFFNAY		Ann (1809)	1-1	Mary Ann (1809)	1-1, 2-1
Anne	5-8	Anna	5-11	Mary Elizabeth (Betty) (1912)	5-1, 5-12
David	5-8	Anne	5-9		
Leo	5-1, 5-8	Annette	5-11		

Mary Louise	5-12	Jane	5-11	Myrtle	6-6
Mathew Barry	5-12	Lynette	5-11	Noeline	6-6
Melissa	5-10	Stephen	5-11	Phyllis	6-6
Michael	5-9, 5-12	HAWKEN		Zilla	6-7
Michael James (1978)	5-2	Dora (1905)	6-1	JAKES	
Michelle (1970)	5-14	Godfrey	6-1	Mary	6-1, 6-6
Milan Bernard Robert	5-12	HAYES		JARMAN	
Missisa	5-11	Edward	2-2	Derek	6-5
Monica	5-2	HAYWARD		Gregory	6-5
Nora	5-7	Raewyn	2-2, 2-4	Neil	6-4, 6-5
Norma Agnes Mary (1901)	5-1, 5-1	HEARD		JARVIS	
	2	Thomas	2-3	Judith	2-11, 2-12
Oliver Francis Gibson (1992)	5-3	HEENEY		JOHNSTON	
Olivia Mary (1980)	5-12	Alexander (Alex)	2-6	Craig	2-14
Patricia	5-9	David	2-6, 2-7	Helen	2-14
Patrick	5-2	Kimberley	2-7	Warran	2-14
Paul	5-9	Tiffany	2-7	JORDAN	
Pauline	5-2, 5-12	HEY		Mathew	5-3
Peter	5-4, 5-10, 5-11	Andrew	2-13	Warren	5-2, 5-3
Peter Alexander	5-9	Frank	2-13	Zeta	5-3
Philip John (1951)	5-2	Ian	2-13	KENDALL	
Philippa	5-11	Karen	2-13	Deon	2-17
Raymond	5-14	Linda	2-13	Glen	2-17
Richard	5-11	Robert	2-13	Leyton	2-17
Richard (1787)	1-1	HIGGINS		Lyndon	2-17
Richard (1833)	1-1	Jill	2-15, 2-16	Mark	2-17
Richard (Dick) Patrick (1932)	5-12	Simon	6-2	KEYES	
Richard Edmond (Frank) (1904)	5-1	HOCKING		Lorraine	5-14
Richard Henry Mary (1864)	5-1	Jane	2-12	KHONGATHAPPA	
Ronald	5-9, 5-10	HODGSON		Anchelle	5-12, 5-13
Ronald (Mike) Michael (1953)	5-12	Leo	5-1, 5-12	KING	
Ronald Joseph (1903)	5-1, 5-12	Margaret	5-14	Alan	5-2
Ronald Michael (1981)	5-12	Mary	5-12	KINGHAM	
Rosemarie	5-9	HOLDEN		Gillian	6-1, 6-2
Russell Stephen (1949)	5-2	Antony	2-11	KINGIPOTIKI	
Sara Jane (1946)	5-2	Dean	2-11	Alan	5-3
Sheree	5-12	William	2-11	Tane	5-3
Stephen	5-4	HOLMAN		Violet	5-3
Stephen Russell (1977)	5-2	Humphery Charles	3-1	KISSLING	
Susan	5-11	HOLMES		Bruce	6-1, 6-2
Tate James Walter	5-1	David Bernard	5-12, 5-13	Elizabeth	6-2
Taylor-Rae (1991)	5-14	Doug	5-12	Jane	6-2
Terence	5-14	Gareth	5-13	Sally	6-2
Teresa (1816)	1-1	Gayne	5-13	KITAS	
Therese	5-2, 5-3, 5-12	Geoffrey	5-13	Pheola (1955)	3-1
Tom	5-11	John Douglas	5-12	LONDON	
Vincent Edward (1906)	5-1	Steven	5-13	Agnes Marie (1868)	3-1
Walter	5-1	Travers	5-13	Alan	3-1
Walter (1781)	1-1	Vanessa	5-13	Anitia (1970)	3-1
Walter Edward (1916)	5-1, 5-14	HOPE		Cecil Frederick William (1891)	3-1
Walter Francis Thomas	5-2	Anthony	5-7	Cecilia Helen (1865)	3-1
Walter Mary	5-1	Christopher	5-7	Charles Aloysius (1868)	3-1
Walter Mary (1818)	1-1, 5-1	Damien	5-7	Charles Richard	3-1
Walter Philip Mary (Phil)	5-1, 5-2	Marie	5-7	Cyril Trevis (1874)	3-1
Winifred	5-1	Mark	5-7	Cyril Trevis (1914)	3-1
Winifred (1821)	1-1	Nicholas	5-7	David	3-1
HALLGARTH		Paul	5-7	Edward Charles (1888)	3-1
Ann	2-5, 2-9	Ralph	5-7	Fredrick Cecil (1917)	3-1
HANCASTLE		Sarah	5-7	Gertrude Mary (1871)	3-1
Unknown	6-6	HOW		June Margaret (1929)	3-1
HANCOCK		Judith	6-3	Mark (1956)	3-1
Brett	2-13	HOWE		Michael (1971)	3-1
Cherie	2-13	Thomas	7-1	Richard Noel (1912)	3-1
Jennifer	2-13	HUCKER		Rose Marie (1867)	3-1
Julie	2-13	Jeremy	6-2	Stephen (1953)	3-1
Wayne	2-13	HULME		Suzanne Gretchen (1946)	3-1
HANLEY		Fredrick	2-15, 2-16	Theo (1989)	3-1
Eileen	5-2	Julie	2-16	Theresa Mary (1862)	3-1
HANSBY		Kathleen	2-16	William Trevis (1860)	3-1
Catherine	2-10	Lynda	2-16	LANE	
Donald	2-5, 2-10	HUNT		Amy	6-6
Donna	2-10	Carla	2-3	LATIMER	
Fiona	2-10	Kerry	2-3	Pamela	2-14
Kevin	2-10	Lynden	2-3	LAUDER	
Kirsten	2-10	HUTCHENSON		Terence	2-15, 2-17
Lisa	2-10	Unknown	5-1	LeCREN	
Natalie	2-10	INDER		Rosalie	5-11
Wayne	2-10	Mary	5-1	LEECH	
HANSEN		INNES		Daniel James	2-16
Gloria	5-5	Gwendolyn	2-11	Nikkie Lee	2-16
HARDY		INWOOD		Rodney	2-16
Grant	2-14	Nagaire	5-8	LEONARD	
Iris	2-15, 2-16	ISAACS		Mary (1847)	6-1
Raymond	2-14	Margaret Ann (1952)	5-2	LEWES	
Richard	2-14	ISLES		Alison	6-2
Robert	2-14	Janice	2-5	Angela (1930)	6-1, 6-2
HARRIS		Thomas	2-5	James	6-2
Adele	5-1	Treana	2-5	Jennifer	6-2
Adele (1919)	5-14	IVANY		Llanfair	6-1, 6-2
HARRIS-ISLES		Unknown	6-6	Noel	6-1
Robyn	2-6, 2-7	JACOBSEN		LINWOOD	
HARRISON		Alex	6-7	Kevin	5-12
Mary	6-4, 6-5	Alexander	6-1, 6-7	Mark	5-12
HART		Charles	6-1, 6-6	Neville	5-12
Allan	6-7	David	6-6	Raymond	5-12
Graham	6-7	Edward	6-7	LLOYD	
Margaret	6-7	Eric	6-6	Adrian Fredrick (1949)	4-2, 4-3
HARVEY		Gilla	6-6	Agnus Hailes (1874)	4-1
Edith	2-1	Jean	6-6	Agnus Lilian (1905)	4-2
Edith 1878	2-11	Joseph	6-1	Alan	2-15, 2-18
HASSELL		Madge	6-7	Aloysius Joseph (1862)	4-2
Brian	5-11	Mary	6-1, 6-7	Aloysius Joseph (1862)	4-1
Geoffrey	5-11	Molly	6-6	Aloysius Joseph (Louey) (1862)	4-1

Annalene	2-18	MANGAN		Dorothy	5-9
Augustine (Austin) (1881)	4-1	Wallace	6-1	John	5-9, 5-10
Bernard John (1868)	4-1	MANGELSDORF		Julie	5-9
Brett	2-17	Arthur	2-13	Mark	5-9
Brian	2-15, 2-17	Craif	2-13	Matthew	5-10
Captain Frances (1900)	4-2	Danan	2-13	Nicholas	5-10
Carol Anne (1964)	4-3	Deborah	2-13	Paul	5-9, 5-10
Charles Albot (1873)	4-1, 4-2	Tracey	2-13	Samual	5-10
Charles Bernard (1920)	4-2	MARCEAU		Terence	5-9, 5-10
Christine	2-18	Yvonne	2-12	MULQUEEN	
Dame Mary	4-2	MARR		Anita	5-9
Daryl	2-17	Charles	2-5, 2-6	Anthony	5-9
Doreen	2-15	Merridy	2-6	Daniel (Dan)	5-9
Edith (1903)	4-2	MARSH		Ellen	5-9
Edith Mary (1864)	4-1	Margaret Ann (1934)	4-2, 4-3	Kevin	5-9
Edward Richard (Eddie) (1863)	4-1	MARTIN		Mary	5-9
Faith	2-18	Alison	2-4	MUNRO	
Francis Thomas (1867)	4-1	David	2-5	Robert	2-8
Fredrick Joseph (1866)	4-1, 4-2	MATHERSON		MURDOCH	
Gerald (1902)	4-2	Sarah	5-2	William	2-14
Hilda	2-15	MATHESON		MURDOCK	
Jason Heath	4-3	Erin	2-2	Neil	2-14
John (1877)	4-1	Graham	2-2	Stuart	2-14
John Bernard (1930)	4-2, 4-3	Jennifer	2-2	Trevor	2-14
John Stephen (Jack) (1879)	4-1	Kenneth	2-2	William	2-14
Jonathan David (1958)	4-3	Kyle	2-2	MURPHY	
Joseph Edmond (1875)	4-1	Robert	2-2	Christina Peace	3-1
Judith	2-15, 2-18	McANENEY		Christina Peace (1918)	3-1
Justin Bernard	4-3	Craig	2-9	MURRAY	
Kevin	2-15, 2-17	Deanne	2-9	Agnes	2-2
Lisa	2-18	James	2-9	Albert	2-2
Margaret	4-2	Lisa	2-9	Alice	2-2
Martin	2-15, 2-17	McBRIDE		Angela	2-4
Mary Clare (1870)	4-1	Amy	2-9	Ann	2-2, 2-4
Mary Geraldine (1903)	4-2	Dean	2-9	Anthony	2-4
Mary Josephene (1907)	4-2	McCABE		Bernadette	2-4
Michael	2-18	Mary	5-8	Brian	2-4
Nadia	2-18	Maryanne	5-8	Christopher	2-4
Nora Ellen	2-15	Patrick	5-8	David	2-4
Patricia	2-17	McCARTNEY		Eileen	2-2
Patricia Mary (1947)	4-2, 4-3	Elizabeth Catherine (Cath)		Frances	2-4
Pauline Agnus (1928)	4-2	(1906)	5-1, 5-2	Gerard	2-2, 2-4
Philop	2-18	McDONALD		John (1864)	2-2
Richard Gerrard (1956)	4-3	Brigid	2-2	John (1964)	2-1
Rita	2-15	Denis	2-2	Joseph	2-4
Roger	2-18	Kevin	2-2	Kathleen	2-4
Rosie	2-15	McHUGH		Mary	2-2, 2-4, 5-1
Russell	2-15, 2-18	Maryann	2-12	Maurice	2-2, 2-4
Stacy	2-18	McKAY		Michael	2-4
Stanislaus Gabriel (1883)	4-1	Brian	2-8	Nigel	2-4
Susan Bernadette (1945)	4-2, 4-3	George	2-8	Patrick	2-4
Thomas	2-1	Ian	2-8	Paul William	2-2
Thomas (1884)	2-15	Kerry	2-8	Peter	2-4
Thomas Austin (1871)	4-1	Kevin	2-8	Rita 1910	2-2
Thomas Napoleon (1836)	4-1	Marie	2-8	Robin	2-4
Trevor	2-15, 2-18	Noel	2-5, 2-8	Roseita 1903	2-2
Valerie	2-15, 2-18	Sheryl	2-8	Stephanie	2-4
Veronica Mary Annette (1877)	4-1	Shona	2-8	Teresa	2-2, 2-4
LOUD		Tania	2-8	NANKERVIS	
Charles	2-5	McLEAN		Antony	2-5
Cyril	2-5	Bruce	6-5	NEELEY	
Margaret	2-5, 2-6	Lesley	6-5	Andrea	5-5
LOXTON		Murray	6-5	Fraser	5-5
Kathryn	2-16	Peter	6-4, 6-5	Graham	5-5
LYNCH		McLEOD		NEWMAN	
Margaret	5-14	Brenton	2-17	Mary	2-1
LYONS		McLINDON		Mary 1879	2-13
William	2-14	Tom	6-5	NICHOLAS	
MacARTHUR		McMORRAN		Brendon	2-16
Margaret	2-5	Elizabeth	6-1, 6-3	Daryl	2-16
MACKLE		McMULLAN		George	2-15
Austin	5-8	Maud	5-1	Marlene	2-15, 2-17
Beverly	5-8	MELVILLE		Raymond	2-15, 2-16
Brian	5-8	Charles	2-6	Robin	2-16
Christine	5-8	John	2-5, 2-6	NICHOLLS	
Eddie	5-8	Mary Ann	2-6	Judith	6-1, 6-3
Edward	5-8	MILLS		NIDDRIE	
Fances	5-8	Timothy	2-16	Barbara (1954)	5-12
Jack	5-1, 5-8	MORAN		NORMAN	
John	5-8	Hugh	6-7	Ben	6-2
Kevin	5-8	Jack	6-7	Cindy	6-2
Margaret	5-8	John	6-7	Dane	6-2
Marie	5-8	Ruth	6-7	James	6-1, 6-2
Marilyn	5-8	MORRIS		Mark	6-2
Nora	5-8	Phillipa	2-16	Philip	6-2
Pat	5-8	MORRISON		Vigot	6-1
Patricia	5-8	Margaret	2-11	O'BRIEN	
Walter	5-8	MOULD		Colleen	6-7
MACKY		Antony	2-6	Karen	6-7
Anna	6-6	Benjamin	2-6	Neil	6-7
Bill	6-6	Damien	2-6	Nell	5-1, 5-12
Bob	6-6	Geoffrey	2-6	Roy	6-7
Claire Margaret	6-6	Helen	2-6	O'CONNOR	
Dane	6-6	John	2-6	Denis	5-8
Edward	6-6	Marita	2-6	Mark	5-8
Joseph	6-6	Percy	2-5, 2-6	Peter	5-8
Julia	6-6	Susan	2-6	Vincent	5-8
Kim	6-6	Valerie	2-6	O'FLAHERTY	
Oliver	6-6	MOYNIHAN		Ann	2-2
MACPHERSON		Alexander	5-9, 5-10	Brian	2-2
Maureen (1928)	5-2	Anna	5-10	Helen	2-2
MAILLEY		Clare	5-9, 5-10	Hugh	2-2
Katherine	2-3	Daniel	5-10	Kathleen	2-2

Martin 2-2
 Patricia 2-2
 O'NEIL
 Ben 6-5
 Nick 6-5
 O'REILLY
 Catherine 6-7
 Charles 6-1, 6-7
 Kevin 6-7
 Marcella 6-7
 Margaret 6-7
 Mary 6-7
 OAKLEY
 Brenda 2-2
 Louise 2-2
 Raymond 2-2
 OATLEY
 Joan 2-15, 2-18
 PALMER
 Brett 5-5
 Catherine 5-5
 Christine 5-5
 Cindy 5-5
 Clive 5-1, 5-5
 Eden 5-5
 Gregory 5-5
 Jacky-Ellen 5-5
 Joanne 5-5
 June 5-5
 Karen 5-5
 Linton 5-5
 Lynette 5-5
 Max 5-5
 Michael 5-5
 Neville 5-5
 Noeline (1929) 5-5
 Pamela 5-5
 Patricia 5-5
 Rodney 5-5
 Russell 5-5
 Sandra 5-5
 Susan 5-5
 Vicky 5-5
 PARDOE
 Steve 2-12
 PARKER
 Mary Frances (1790) 1-1
 PARSONS
 Bernard 6-7
 Bernice (Bobs) 5-1, 5-11
 Maureen 6-7
 Michael 6-7
 Patricia 6-7
 Peter 6-7
 PATRICK
 Olive Mary (1914) 5-1, 5-12
 PATTERSON
 Craig 2-13
 PAULSON
 Christine 3-1
 PEARCE
 Alison 2-10
 PEARSE
 Joseph 6-1
 Lynne 2-9
 PEASE
 Anna 6-3
 Anthony 6-3
 David 6-1, 6-3
 Diane (1934) 6-1, 6-3
 Elsie Rae (1901) 6-1
 Fiona 6-3
 James J (1907) 6-1
 Janet (1937) 6-1, 6-3
 Jeremy 6-3
 John 6-1, 6-3
 Joseph (1861) 6-1
 Kate 6-3
 Lillian F (1904) 6-1
 Michael 6-1, 6-3
 Phillip 6-3
 Rachel 6-3
 Ruth 6-1
 Simon 6-3
 Timothy 6-3
 Violet L (1898) 6-1
 PECKMAN
 Dorothy Jean 3-1
 PENDRELL
 Joseph 1-1
 Lucy J (1818) 1-1, 6-1
 PERRY
 Gretchen Lilian Amelia (1913) 3-1
 PETHYBRIDGE
 Diane 2-13
 PETTERSEN
 Haig 2-9
 Heidi 2-9
 Kirsten 2-9
 Neil 2-5, 2-9
 POTHAN
 Basil 2-5
 Shirley 2-5, 2-10

PRIEST
 Antony 2-12
 Basil 2-11, 2-12
 Catherine 2-12
 Derrick 2-12
 Emily 2-12
 Emma 2-12
 Georgina 2-12
 Jeremy 2-12
 Joanna 2-12
 Michael 2-12
 Nigel 2-12
 Rebecca 2-12
 Russell 2-12
 Victoria 2-12
 Warren 2-12
 RALFE
 Desmond 5-7
 Jane 5-7
 Mary-Anne 5-7
 Mathew 5-7
 Patrick 5-7
 Terry 5-7
 Tim 5-7
 RANGI
 David 2-11, 2-12
 Debra 2-12
 RANKIN
 Alan 5-4
 Gertrude 4-2
 Keith 5-4
 Murray 5-4
 RAVI-PINTO
 Carla 2-9
 REED
 Christopher (1985) 6-5
 Lucinda (1987) 6-5
 Noel 6-4, 6-5
 REEVE
 Nicola 2-4
 REID
 Marjorie 2-13
 REWI
 Teao 2-13
 RIDLEY
 Justine 2-13
 RINETT-CARNAC
 Marie 5-5
 ROBINSON
 Graeme 2-9
 Gweneth 2-2, 2-3
 Shirley 2-9
 ROCKICH
 Rose 5-12
 ROE
 Allan 2-3
 Anna 2-3
 Arthur 2-2, 2-3
 Charlotte 2-3
 John 2-3
 Karen 2-3
 Maureen 2-3
 Michael 2-3
 Victoria 2-3
 ROGERS
 Barbara 6-6
 Stanley 2-15
 ROWE
 Daniel 6-3
 Gerard 6-3
 Ian 6-1, 6-3
 Shane 6-3
 ROWELL
 Paul 2-15, 2-17
 Phillip 2-17
 Wayne 2-17
 RUMBALL
 Ruth 2-12
 RUTHERFORD
 Unknown 6-6
 RUTHERFORD-BELL
 Gordon 6-7
 John 6-7
 Terence 6-7
 SABLE
 Celeste 2-3
 SALMON
 Kathleen 2-2
 Leonie 2-5, 2-8
 Ngaire 2-5, 2-8
 William 2-5
 Yolande 2-5, 2-8
 SALVS
 Sheila Joan 4-2
 Shella Joan 4-3
 SANDLER
 Ann 4-2
 David 4-2
 John 4-2
 Joseph 4-2
 Paul 4-2
 Peter 4-2
 Richard 4-2

SCHERP
 Valerie 2-11, 2-12
 SCOTT
 John 2-15, 2-17
 Lianne 2-17
 Sandra 2-17
 Wendy 2-17
 SCULPHIR
 Maree 5-5
 SEED
 Janice 2-15, 2-17
 Junne 2-15, 2-17
 Shirley 2-15, 2-17
 William 2-15
 SENIOR
 Mary 5-1, 5-4
 SERGENT
 Coral 5-12
 SHALDRICK
 Margaret 2-1, 2-13
 SHAW
 Andrew 2-4
 Bridget 2-4
 George 2-2, 2-4
 Ian 2-4
 Jake 5-5
 Jane 5-1
 Josiah 2-4
 Karen 2-4
 Kerry 5-5
 Lana 2-4
 Lindy 2-12
 Michael 2-4
 Peter 5-5
 Stephen 2-4
 Suzannah 2-4
 SHEDDAN
 Shirley 2-15, 2-16
 SHING
 Linda 2-16
 SHORT
 Craig 6-5
 Jason 6-5
 SLAKO
 Nellie 5-1, 5-12
 SLATER
 Charles 2-5
 Maizie 2-5, 2-6
 Nina 2-5, 2-6
 SLAVIN
 Blair Maynard (1972) 5-2
 Calum (1974) 5-2
 Martin Ray (1970) 5-2
 Ray 5-2
 SLOMP
 Amanda 5-12, 5-13
 SMITH
 Colin 6-4, 6-5
 Diane 2-9
 Jocelyn 2-15, 2-18
 Lianne (1962) 6-5
 Melinda J (1967) 6-5
 Phillipa T (1969) 6-5
 Stephen (1960) 6-5
 Wendy 6-4, 6-5
 SPARROW
 Agatha (1879) 6-1, 6-6
 Albert 6-1, 6-6
 Arthur George (1874) 6-1
 Bruce 5-7
 Charlotte (1871) 6-1
 Eric (1843) 6-1
 Frank 6-6
 Frank (1876) 6-1
 Joanne 5-7
 Lindsay 5-7
 Martin 5-7
 Mary Elizabeth (1872) 6-1, 6-4
 Mereta 5-7
 Rhoda L (1869) 6-1
 Rosaline Harriet (1884) 6-1, 6-6
 Stephen 5-7, 6-6
 Stephen Robert (1880) 6-1
 SPEIR
 Reuben 6-1
 STANLEY
 Aaron 2-12
 Andrew 2-12
 Elisha 2-12
 Rebecca 2-12
 STEEL
 Margaret 6-1, 6-7
 STEVENS
 Dawn 2-8
 Kara 2-8
 Shannan 2-8
 STEWART
 Ann 6-4, 6-5
 STIVIN
 Cecil 5-8
 STRINGER
 Raewyn 5-2
 SUTTON

Janice 2-17
 SYMES
 Thelma 2-5
 TARR
 Margaret 2-11
 TATE
 Mary Ellen 5-1
 TATUM
 Raie 2-6
 TEMPLETON
 Shelly 5-9, 5-10
 THOMPSON
 Andrea 6-5
 Claire (1942) 6-4, 6-5
 David 6-5
 Elizabeth (1930) 6-4, 6-5
 George 6-5
 George (1945) 6-4
 George Eric (1902) 6-4
 Janet (1952) 6-4, 6-5
 Jennifer 6-4, 6-5
 Joan 6-4, 6-5
 John W (1905) 6-4
 Kylie 6-5
 Margaret Alison (1936) 6-4, 6-5
 Nan 2-15, 2-17
 Pamela 6-5
 Pamela (1934) 6-4
 Peter 6-5
 Richard 6-1
 Richard (1847) 6-4
 Richard (1932) 6-4, 6-5
 Robert 2-6
 Roger W (1939) 6-4
 Ross 6-5
 THOMSON
 Raewyn 5-14
 TOBIN
 Cecilla 5-4
 TODD
 Diane Evelyn Jean (1923) 4-2
 TREVIS
 Helen (1836) 3-1
 John 1-1
 John (1778) 3-1
 TRYBULA
 Eddie 5-7
 Joshua (1987) 5-7
 Luke (1981) 5-7
 TUCKER
 Antony Robert 2-6
 Barbara 2-6, 2-7
 Ben 2-7
 Hellen Louisa 2-6
 John 2-6, 2-7
 Jullianne 2-6
 William 2-6
 TUCKER-WALLACE
 Sally 2-15, 2-17
 TULLOCH
 Jennifer 6-1, 6-3
 TULLY
 Gerard 5-7
 TURNBULL
 Fiona Lisa 2-8
 Lynne 2-8
 William 2-5, 2-8
 UFFENDEL
 Rob 2-11
 UPTON
 Allison 2-9
 Bradley 2-9
 Carroll 2-9
 Diane 2-9
 Donna 2-9
 Elizabeth 2-9
 Eric 2-9
 Fluor 2-9
 Guy 2-9
 Hilary 2-9
 John 2-9
 Keith 2-9
 Kevin 2-9
 Matthew 2-9
 Michael 2-9
 Murray 2-5, 2-9
 Noel 2-9
 Phillip 2-9
 Phillipa 2-9
 Tracy 2-9
 Ursula 2-9
 Warrick 2-9
 VICKERS
 Olive 2-11
 Von BAUER BORGEHN
 M 4-1
 WALL
 Zena Theresa 3-1
 Zena Theresa (1915) 3-1
 WALLACE
 David 2-18
 Marie 2-18
 Nigel 2-15, 2-18

WARD
 Aloysius 5-1
 Amy 5-1
 Charles 5-1
 Evelyne 5-1
 Frances Ann 1-1, 5-1
 Frank 5-1
 Ivy 5-1
 Vera 5-1
 Winifred 5-1
 WARMERDAM
 David Landon (1972) 3-1
 Hubertus Nickolaas Maria 3-1
 Ian Landon (1968) 3-1
 Nicole Landon (1971) 3-1
 WATERHOUSE
 Brett 2-3
 Craig 2-3
 Dean 2-3
 James 2-3
 Scott 2-3
 WATERS
 Brenda 5-8
 WEBB
 David 2-11
 Michael 2-11
 Nigel 2-11
 WEBBER
 Alison 2-16
 Carolyn 2-16
 Catherine 2-16
 Catriona 2-16
 Clair Frances 2-16
 Colleen 2-15
 Desmond 2-15, 2-16
 Elaine 2-15, 2-16
 Fiona 2-16
 Geoffrey 2-16
 Helen 2-16
 Howard C 2-15
 Howard L 2-15, 2-16
 Jennifer 2-16
 Kenneth 2-16
 Lyn 2-16
 Matthew 2-16
 Paul 2-16
 Philip 2-16
 Ronald 2-15, 2-16
 Samual 2-16
 WHEELER
 Colin 6-5
 Linda 6-5
 Malcom 6-5
 Sue 6-6
 Trevor 6-4, 6-5
 Warren (1954) 6-5
 WHITEHEAD
 Douglas 6-1
 WIELY
 Jane 5-2, 5-3
 WILLIAMS
 Charles Lawrence 3-1
 Mark 5-12
 Unknown 1-1
 WILLS
 Barbara 2-12
 WILSON
 Anna 5-3
 Barry 2-12
 Bonnie 2-12
 Chris 5-2, 5-3
 Daniel 5-3
 Douglas 2-11, 2-12
 Edward 5-3
 Heather 2-12
 Kelly 2-12
 Kevin 2-12
 Leonard 2-12
 Patrick Michael 5-3
 Paul 5-2, 5-3
 Rosemary 5-3
 Simon 5-3
 Steven 2-12
 WINIFRED
 Mary 1-1
 WINTER
 Mary 5-8
 WOODS
 Wendy 2-3
 WORTH
 Ivy 2-14
 WRACK
 Barbara 2-9
 WRIGHT
 Malcolm 2-11
 YONDALL
 Erin 2-16
 Rowan 2-16
 Stacy 2-16
 YOUNG
 Leo 3-1
 ZYSKOWSKI
 Alexander 5-10

Bernie 5-9, 5-10
 Grace 5-10
 Rosanne 5-10